

PI-100 model

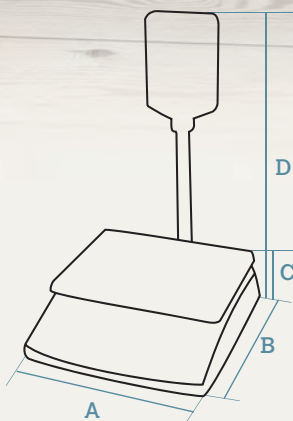

Dimensions



DATA IN mm

	PI-100 S	PI-100 T
A	288	288
B	313	367
C	109	109
D	-	480

Plate dimensions: L263 x W204 mm.

Packaging measures:
- PI-100 F: L345 x W370 x H195 mm.
- PI-100 P: L340 x W510 x H195 mm.

Weight with packaging:
- PI-100 F: 4.1 kg / PI-100 P: 4.7 kg.



**Cely PI
SERIES**



**LCD
SEGMENT
DISPLAY**



**UP TO
10 PLUs**



RS-232



**RECHARGEABLE
INTERNAL
BATTERY**



**METROLOGICAL
VERIFICATION
OPTIONAL (EU)**

Characteristics and functionality

Main characteristics

- Price computing electronic scale without printer.
- Rechargeable internal battery:
 - > Up to 60 hours' runtime with battery at full charge and backlight off (approximate data).
- Valid for legal metrology.

Features

- Fix tare.
- Manual zero.
- 10 PLUs in memory - 4 direct PLUs.
- Energy saving via programmable on and off back lighting switching.
- Operating temperature: -10°C to +40°C.

Capacity / Accuracy

- Multi-interval: 3 kg / 1 g - 6 kg / 2 g, 6 kg / 2 g - 15 kg / 5 g or 15 kg / 5 g - 30 kg / 10 g.

Available formats

- Flat.
- Pole.

Construction

- Structure:
 - > ABS plastic casing.
- Displays:
 - > 3 backlit LCD segment displays in vendor side and buyer side.
 - > 6 digits (H15 mm) per display.
 - > Show weight, price / kg and total.
- Keypad with 20 keys.
- Plate:
 - > Type: Flat.
 - > Material: Stainless steel.

Communication to PC / POS / ECR

- RS-232.
- Protocols available to connect to most of the POS/ECR in the market.

Power supply

- Mains: AC 12 V / 500 mA adapter.
- Rechargeable internal battery: Pb 6 V / 3.2 Ah.

Energy consumption

- 1.8 W (approx.) with backlight activated.

Models

Flat Format

	Displays	PLUs	Direct PLUs	Power	Capacity/Accuracy	Reference
PI-100 F 3/6	LCD Segment	10	4	Mains / Battery	3 kg / 1 g - 6 kg / 2 g	71AI100S0028UE
PI-100 F 6/15	LCD Segment	10	4	Mains / Battery	6 kg / 2 g - 15 kg / 5 g	71AI100S0029UE
PI-100 F 15/30	LCD Segment	10	4	Mains / Battery	15 kg / 5 g - 30 kg / 10 g	71AI100S0031UE

Pole Format

	Displays	PLUs	Direct PLUs	Power	Capacity/Accuracy	Reference
PI-100 P 3/6	LCD Segment	10	4	Mains / Battery	3 kg / 1 g - 6 kg / 2 g	71AI100T0028UE
PI-100 P 6/15	LCD Segment	10	4	Mains / Battery	6 kg / 2 g - 15 kg / 5 g	71AI100T0029UE
PI-100 P 15/30	LCD Segment	10	4	Mains / Battery	15 kg / 5 g - 30 kg / 10 g	71AI100T0031UE

(M) optional

Options

Option	Characteristics	Ref.
Metrological verification (M)	According to EU weighing directives. (See section on equipment metrological verification).	Consult

Accessories

DB9-DB9 cable

RS-232 communications cable.

Ref: W16371BAA



Note:

- The references correspond to standard models: Black ABS plastic casing, backlit LCD segment displays, flat stainless steel plate and RS-232 interface. Capacity: multi-interval, from 3 / 6 kg to 15 / 30 kg.

PRICE COMPUTING
SCALE

G-325 model

scales without
printer
03



Dimensions

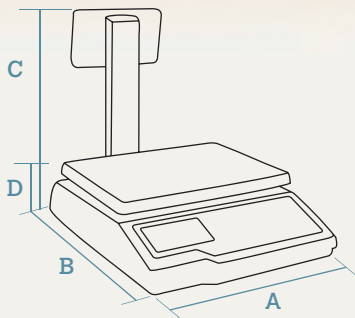

DATA IN mm

A	320
B	400
C	356
D	116

Plate dimensions: L305 x W235 mm.
Weight with packaging: 6.0 kg.



LCD
SEGMENT
DISPLAY



UP TO
100 PLUs



RS-232

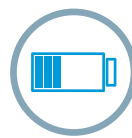

INTERNAL
RECHARGEABLE
BATTERY
IN G-325 B F/P



METROLOGICAL
VERIFICATION
OPTIONAL (EU)

Characteristics and functionality

Main characteristics

- Price computing electronic scale without printer.
- RS-232 interface: firmware and communication protocols upgradeable from PC.
- Valid for legal metrology.
- Internal rechargeable battery:
 - > Up to 120 hours of life with completely charged battery and back lighting disconnected (approximate data).

Features

- EAN heading programming (according to communication protocol).
- Tare, fix tare and manual zero.
- Fix price: to operate several times with the same article.
- Display of price in a secondary currency.
- Energy saving via programmable on and off back lighting switching and automatic disconnection.

Capacity / Accuracy

- Multi-range (3,000 divisions): 6 kg / 2 g - 15 kg / 5 g.
- Optional:
 - > Multi-range (3,000 divisions): 15 kg / 5 g - 30 kg / 10 g.

Available formats

- Flat and pole in the same scale: the tower is included in the packaging and is easily installable.

Construction

- Structure:
 - > ABS plastic casing.
- Displays:
 - > 5 digits backlit LCD segment display in vendor and buyer side.
 - > Show weight, price / kg and total.
- Keypad with 32-keys.
- Plate:
 - > Type: Flat.
 - > Material: Stainless steel.

Communication to PC / POS / ECR

- RS-232 interface.
- Communication protocols available for the main POS and ECR in the market.
- Multi-protocol: communication protocol is selected in the scale (40 protocols available). More protocols can be added from PC by telecharge (maximum: 60 protocols more).
- "OPOS" driver.

Power supply

- Mains: 220 VAC with AC/DB 12 V / 500 mA adapter.
- 6 VDC / 4.5 Ah rechargeable internal battery available (only in G-325 B F/P) and connection to external battery.

Energy consumption

- G-325: 3 W (approx.).
- G-325 B: 3.5 W (approx.).

Models

	Displays	PLUs	Direct PLUs	Communication protocols	Power	Capacity / Accuracy	Reference
G-325 F/P	LCD Segment	100	9x2	Up to 100	Mains	6 kg / 2 g - 15 kg / 5 g	70321S00NE__
G-325 B F/P	LCD Segment	100	9x2	Up to 100	Mains / Battery	6 kg / 2 g - 15 kg / 5 g	70321S02NE__

(M) optional

Options

Option	Characteristics	Ref.
Capacity 15 kg / 5 g - 30 kg / 10 g	Multi-range (3,000 divisions).	...F__ (*)
Metrological verification (M)	According to EU weighing directives. (See section on equipment metrological verification).	Consult

(*) The scale references with this capacity are obtained by replacing the last characters of the reference for the standard scale with the indicated ending.

Accessories

Italian plate

L357 x W235 x H55 mm.

The Italian plate is placed on the flat plate. A new weight adjustment might be necessary. Consult.

Ref: BCR71



Note:

- The references correspond to standard models: Black ABS plastic casing, LCD segment display, flat stainless steel plate and RS-232 communications. Capacity/Accuracy: 6 kg / 2 g - 15 kg / 5 g.

WEIGHT ONLY OR
PRICE COMPUTING SCALE

CHECKOUT SCALE

DPOS-400 series



Dimensions

DATA IN mm

A	50
B	275
C	65
D	345
E	420*
F	45

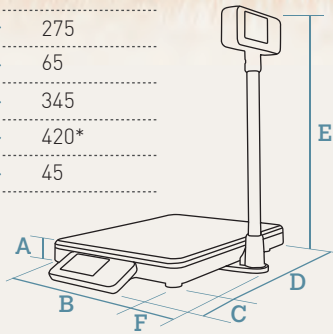

Plate dimensions: L300 x W230 mm.
Weight with packaging: 5.0 kg.

* + 9.2 mm with glass plate and legs adjusted in height to the minimum.



LCD
GRAPHIC
DISPLAY



RS-232



USB



M
METROLOGICAL
VERIFICATION
OPTIONAL (EU)

Models

Flat Format

	Vendor Display	Buyer Display	Communication protocols	Power through a USB	Capacity / Accuracy	Reference
DPOS-400 F - 1 DISP.	LCD Graphic	-	Up to 100	Mains / Others	6 kg / 2 g - 15 kg / 5 g	7POSP00LNE_
DPOS-400 F - 2 DISP.	LCD Graphic	LCD Graphic	Up to 100	Mains / Others	6 kg / 2 g - 15 kg / 5 g	7POSPP0LNE_

Pole Format

	Vendor Display	Buyer Display	Communication protocols	Power through a USB	Capacity / Accuracy	Reference
DPOS-400 P - 1 DISP.	LCD Graphic	-	Up to 100	Mains / Others	6 kg / 2 g - 15 kg / 5 g	7POST00LNE_
DPOS-400 P - 2 DISP.	LCD Graphic	LCD Graphic	Up to 100	Mains / Others	6 kg / 2 g - 15 kg / 5 g	7POSTT0LNE_
DPOS-400 P - 2 DISP. <i>(1 in base and 1 in pole)</i>	LCD Graphic	LCD Graphic	Up to 100	Mains / Others	6 kg / 2 g - 15 kg / 5 g	7POSPT0LNE_

M optional

Characteristics and functionality

Main characteristics

- Weight only or price computing scale for checkout applications.
- Modular and modern design.
- Easy integration into counters.
- Additional tempeMains glass plate available. Customizable with client's logo.
- Valid for legal metrology.

Features

- EAN heading programming (according to the communication protocol).
- Tare, fix tare and manual zero.
- Display of price in a secondary currency.
- Energy saving via programmable on and off back lighting switching and automatic disconnection.
- Power supply and communications through one single USB cable.

Capacity / Accuracy

- Multi-range (3,000 divisions): 6 kg / 2 g - 15 kg / 5 g.
- Optional:
 - > Mono-range (3,000 divisions): 15 kg / 5 g.

Available formats

- Flat.
- Pole.

Construction

- Structure:
 - > ABS plastic casing.

- Display:
 - > Easy to install in multiple positions (1 or 2 displays).
 - > Backlit LCD matrix graphic display.
 - > 5 digits (up to H20 mm) per display.
 - > Shows only weight or weight, price/kg and total (connected to POS and depending on the communication protocol).
- Keypad with 3-keys.
- Plate:
 - > Type: Flat.
 - > Material: Stainless steel. Also available in tempeMains glass (additional).

Communication to PC / POS / ECR

- RS-232 interface.
- USB.
- Communication protocols available for the main POS and ECR in the market.
- Multi-protocol: communication protocol is selected in the scale (40 protocols available). More protocols can be added from PC by telecharge (maximum: 60 protocols more).
- "OPOS" driver.

Power supply

- Mains: power via USB connection, with an AC/DB adapter from 110/240 VAC to 5 V / 500 mA.
- Others: other sources through a USB connection for example with a PC.

Energy consumption

- 1 W (approx.).

Options

Option	Characteristics	Ref.
Capacity 15 kg / 5 g	Mono-range (3,000 divisions).	...N__ (*)
Metrological verification (M)	According to EU weighing directives. (See section on equipment metrological verification).	Consult

(*) The scale references with this capacity are obtained by replacing the last characters of the reference for the standard scale with the indicated ending.

Accessories

TempeMains glass plate (customizable)

Stainless steel plate also included.



Ref: 494839A

Note:

- The references correspond to standard models: Black ABS plastic casing, backlit LCD segment display, flat stainless steel plate and RS-232 and USB communications. Capacity/Accuracy: 6 kg / 2 g - 15 kg / 5 g.

WEIGHING KITS FOR
INTEGRATION WITH SCANNER

CHECKOUT APPLICATION

KS-400 series



Scanner not
included

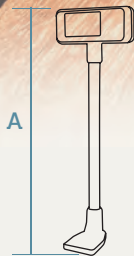

Dimensions
DATA IN mm

A 420

Weight with packaging: 5.0 kg.



LCD
GRAPHIC
DISPLAY



RS-232



USB
(ONLY IN
KS-400 M)



METROLOGICAL
VERIFICATION
OPTIONAL (EU)

Characteristics and functionality

Main characteristics

- Weighing kit to integrate with scanner for checkout applications.
- The display shows: weight only or weigh-price-total.
- The rotary display allows an appropriate reading.
- Modular and modern design.
- Easy integration into counters.
- ECR/POS connection.
- Scanner not included (consult us).
- Valid for legal metrology (connected to POS / ECR).

Features

- EAN heading programming (according to the communication protocol).
- Tare, fix tare and manual zero.
- Display of price in a secondary currency.
- Energy saving via programmable on and off back lighting switching and automatic disconnection.
- Power supply and communications through one single USB cable (only for KS-400 M, and depending on the scanner).
- The weighing components are located in an isolated area, so scanner maintenance operations may be carried out without the need to unseal the equipment.

Capacity / Accuracy

- Multi-range (3,000 divisions): 6 kg / 2 g – 15 kg / 5 g.
- Optional:
 - > Mono-range (3,000 divisions): 6 kg / 2 g, 15 kg / 5 g or 30 kg / 10 g.
 - > Multi-range (3,000 divisions): 15 kg / 5 g – 30 kg / 10 g.

Available formats

- Without displays.
- Display in pole.

Display

- LCD matrix graphic backlit display (1 or 2 depending on the model).
- Shows: only weight or weight-price / kg-total price (connected to a POS and according to the communication protocol).
- Models without a display can display the information on the connected POS screen.

Communication to PC / POS / ECR

- RS-232 interface.
- USB (only in KS-400 M, and depending on the scanner).
- Communication protocols available for the main POS and ECR in the market.
- Multi-protocol: the communication protocol is selected in the weighing kit among the available ones, previously recorded in the weighing kit.
- Upgradeable software from PC.
- "OPOS" driver.

Compatibility with scanners

- Honeywell Stratos MS2421 scanner (communication by one or two cables).
- Datalogic Magellan 8300 / 8400 / 9300i / 9400i / 9800i scanners.
- MP7000 Zebra scanner.

Power supply

- Mains: through the scanner (5 or 12 V).
- Others: other sources through a USB connection for example with a PC. Only in KS-400 M, and depending on the scanner.

Energy consumption

- 1 W (approx.).

Models

Weighing kits compatible with Honeywell Stratos MS2421 scanner*

	Vendor Display	Buyer Display	Scanner communication	Power	Capacity / Accuracy	Reference
KS-400 S POS	-	-	-	POS / Others	6 kg / 2 g - 15 kg / 5 g	7N0E000NE__
KS-400 S - 1 DISP.	-	-	2 cables	Scanner	6 kg / 2 g - 15 kg / 5 g	7N0AT00NE__
KS-400 S - 1 DISP.	LCD Graphic	-	1 cable	Scanner	6 kg / 2 g - 15 kg / 5 g	7N0BT00NE__
KS-400 S - 2 DISP.	LCD Graphic	LCD Graphic	2 cables	Scanner	6 kg / 2 g - 15 kg / 5 g	7N0ATT0NE__
KS-400 S - 2 DISP.	LCD Graphic	LCD Graphic	1 cable	Scanner	6 kg / 2 g - 15 kg / 5 g	7N0BTT0NE__

Weighing kits compatible with Datalogic Magellan scanners*

	Vendor Display	Buyer Display	Scanner communication	Power	Capacity / Accuracy	Reference
KS-400 M POS	-	-	8300 / 8400 / 9300i / 9400i	POS / Others	6 kg / 2 g - 15 kg / 5 g	7N0H000NE__
KS-400 M - 1 DISP.	LCD Graphic	-	8300 / 8400 / 9300i / 9400i	Scanner	6 kg / 2 g - 15 kg / 5 g	7N0CT00NE__
KS-400 M - 2 DISP.	LCD Graphic	LCD Graphic	8300 / 8400 / 9300i / 9400i	Scanner	6 kg / 2 g - 15 kg / 5 g	7N0CCT0NE__
KS-400 M POS	-	-	9800i	Scanner / Others	6 kg / 2 g - 15 kg / 5 g	7N0I000NE__
KS-400 M - 1 DISP.	LCD Graphic	-	9800i	Scanner / Others	6 kg / 2 g - 15 kg / 5 g	7N0DT00NE__
KS-400 M - 2 DISP.	LCD Graphic	LCD Graphic	9800i	Scanner / Others	6 kg / 2 g - 15 kg / 5 g	7N0DTT0NE__

Weighing kits compatible with Zebra scanner*

	Vendor Display	Buyer Display	Scanner communication	Power	Capacity / Accuracy	Reference
KS-400 Z POS	-	-	MP7000	POS / Others	6 kg / 2 g - 15 kg / 5 g	7N0F000NE__
KS-400 Z - 1 DISP.	LCD Graphic	-	MP7000	Scanner	6 kg / 2 g - 15 kg / 5 g	7N0GT00NE__
KS-400 Z - 2 DISP.	LCD Graphic	LCD Graphic	MP7000	Scanner	6 kg / 2 g - 15 kg / 5 g	7N0GTT0NE__

(M) optional

* Scanner not included.

Options

Option	Characteristics	Ref.
Capacity 6 kg / 2 g	Mono-range (3,000 divisions).	...W__ (*)
Capacity 15 kg / 5 g	Mono-range (3,000 divisions).	...N__ (*)
Capacity 30 kg / 10 g	Mono-range (3,000 divisions).	...Y__ (*)
Capacity 15 kg / 5 g - 30 kg / 10 g	Multi-range (3,000 divisions).	...F__ (*)
Metrological verification (M)	According to EU weighing directives. (See section on equipment metrological verification).	Consult

(*) The weighing kits references with this capacity are obtained by replacing the last characters of the reference for the standard weighing kits with the indicated ending.

Note:

- The references correspond to standard models: Backlit LCD graphic display and RS-232 communication. Capacity/Accuracy: 6 kg / 2 g - 15 kg / 5 g.



PRICE COMPUTING SCALE
WITH PRINTER

PI-150
model

500 RANGE ELECTRONIC SCALES

WIND
series

MISTRAL
series

TORNADO
series

STAR
series

TOUCH SCREEN
ELECTRONIC SCALE

D-900
series

PC SCALE

CS-2100
series

CS-2200
series

PRICE COMPUTING SCALE
WITH PRINTER

PI-150 model



Dimensions

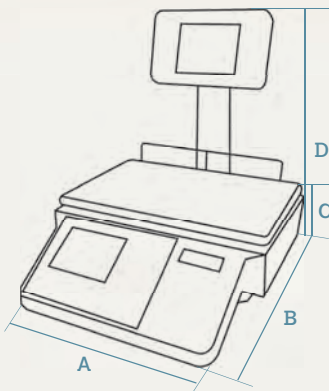

DATA IN mm

A	375
B	444
C	134
D	414

Plate dimensions: L375 x W236 mm.

Packaging measures:
L460 x W490 x H270 mm.

Weight with packaging: 7.6 kg.



Cely PI
SERIES



1 RECEIPT
PRINTER



LCD
SEGMENT
DISPLAY



UP TO
100 PLUS



UP TO
2 VENDORS



RS-232

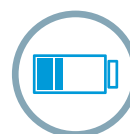

RECHARGEABLE
INTERNAL
BATTERY



METROLOGICAL
VERIFICATION
OPTIONAL (EU)

Characteristics and functionality

Main characteristics

- Price computing electronic scale with receipt printer.
- Valid for legal metrology.

Features

- 100 PLUs in memory - 12 direct PLUs.
- Information for each PLU: name of 9 characters, weighed or unitary, price, pretare, VAT.
- 2 vendors.
- Sales reports: total sales by article or by VAT.
- Fix tare.
- Manual zero
- Change calculation.
- Energy saving via programmable on and off back lighting switching.

Capacity / Accuracy

- Mono-range (3,000 divisions):
> 15 kg / 5 g.
- Multi-range (3,000 divisions):
> 6 kg / 2 g - 15 kg / 5 g
> 15 kg / 5 g - 30 kg / 10 g.

Available formats

- Flat and pole in the same scale: the tower is included in the packaging and is easily installable.

Construction

- Structure: ABS plastic casing.
- Keypads of 33 keys.
- Stainless steel plate with rod.

Displays

- Backlit LCD segment display (W78 x H150 mm) for vendor and buyer.
- 3 lines with 6 digits of H18 mm + 1 alphanumeric line:
> Showing weight, price / kg, total, tare, vendor and name of article.

Printer

- 57 mm thermal printer for receipts.
- Easy-loading system.

Receipts

- Up to 30 lines.
- 3 programmable header lines and 3 lines at the end of the receipt.

Communications

- RS-232.

Security

- Access to different protected programming menus via configurable passwords.

Connectivity with other devices

- PC.
- Cash drawer (6 V).

Power supply

- Mains: AC 12 V / 2,500 mA adapter.
- Rechargeable internal battery: Pb 6 V / 4 Ah.
> To prevent data loss in case of power failure in the network.



500 RANGE
ELECTRONIC SCALES

WIND series





1 PRINTER
RECEIPTS
OR LABELS



**LCD
SEGMENT
DISPLAY**



**OPTIONAL
LCD GRAPHIC
DISPLAY**



**UP TO
5,000 PLUs**



**UP TO
10 VENDORS**



**ETHERNET
TCP/IP**

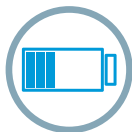

**OPTIONAL
RECHARGEABLE
INTERNAL
BATTERY**



**METROLOGICAL
VERIFICATION
OPTIONAL (EU)**

Characteristics and functionality

Main characteristics

- Electronic scale with higher visibility display options.
- Models with receipt printer or label printer (suitable for receipts).
- Functional and robust design.
- Compliance with EU Regulation 1169/2011 on the provision of food information to consumers (only for W-025).

Features

- Extensive information for each PLU: normal price, price for weight scales and by kg/100 g (in W-020, W-020 B and W-025), 2 names of 20 characters (1 in W-010, W-010 B and W-015), 10 free texts of 24 characters (5 in W-010, W-010 B and W-015), 1 text of 3,000 characters (in W-025), profitability codes, etc.
- PLU search by code or name.
- Preset keys to programming menus: to change prices, register PLUs or vendors, etc.
- Direct access to 999 PLUs from the keyboard.
- Drill down menu.
- Printing of scale menus.
- 2 programmable macros (in W-020, W-020 B and W-025): recording of a sequence of keys to create direct access to

any task (reopening of receipts, lists, change in batcher number, etc.).

- Sales and management reports: sales (by article, vendor, time frames, last month, etc.), balance available in the cash drawer, modified PLUs, etc.
- Fast and reliable communication between scales, with PC and mobile devices (via DWS).
- Stocks management on the scale.
- Stock / order mode.

Capacity / Accuracy

- Multi-range (3,000 divisions): 6 kg / 2 g - 15 kg / 5 g.
- Optional:
 - > Mono-range (3,000 divisions): 15 kg / 5 g or 30 kg / 10 g.
 - > Multi-range (3,000 divisions): 15 kg / 5 g - 30 kg / 10 g.
 - > Mono-range (6,000 divisions): 12 kg / 2 g or 30 kg / 5 g.

Available formats

- Flat.
- Pole.

Construction

- Highly resistant ABS plastic casing.
- Stainless steel plate.

Displays

- Backlit LCD segment display (W150.2 x H43.4 mm) for vendor and buyer (showing weight, price / kg, total, tare, vendors and name of articles).
- Optional:
 - > LCD matrix graphic display (W134 x H41 mm) for vendor and buyer, for W-020, W-020 B and W-025 with 15 kg - 5 g / 30 kg - 10 g multi-range. Possibility of showing: logos, profitability codes and warning messages sent from a PC (on vendor display) and advertising messages with animated effects on buyer display.

Printer

- Models available with 1 printer for receipts or 1 printer for labels (also suitable for receipts by changing the paper roll and the working mode).
- 54 mm thermal printer.
- Resolution: 8 dots/mm.
- Speed depending on models:
 - > W-020 and W-025: 100 mm/sec.
 - > W-010 and W-015: 80 mm/sec.
 - > W-010 B and W-020 B: 60 mm/sec.

Receipts

- All the models:
 - > 15 fonts (6 monospaced + 9 multispaced: more modern and legible).
 - > Up to 40 items.
 - > EAN-13 barcode.
 - > 9 payment methods.
 - > Total in National currency and other 3 different currencies.
 - > Discounts per line and total.
- W-010, W-010 B and W-015:
 - 2 fixed formats.
- W-020, W-020 B and W-025:
 - > 2 fixed formats + 1 programmable format.
 - > 4 logos per receipt.
 - > Name of vendor.
 - > Customers on account.



Labels

- All the models:
 - > 15 fonts (6 monospaced + 9 multispaced: more modern and legible).
 - > 40 logos.
 - > EAN-13 barcode.
 - > 40 fields of information.
 - > 100 programmable texts.
 - > Manual and automatic pre-packaging modes.
 - > Automatic adjustment of the paper detection sensor.
- W-015:
 - > From W30 x L30 mm to W60 x L80 mm.
 - > 20 fixed formats + 5 programmable formats.
 - > 1 type of generic traceability (for meat, fish, fruits, vegetables, etc.) up to 10 products. Included in the prevailing European legislation on bovine traceability.
- W-025:
 - > From W30 x L30 mm to W60 x L100 mm.
 - > 20 fixed formats + 10 programmable formats.
 - > 3 levels of totals.
 - > Printing of "n" identical labels.
 - > Printing with 90°, 180° and 270° rotation.
 - > Packaging date, expiry date and extra date (for any application).
 - > Alphanumeric batch number.
 - > 2 types of generic traceability (for meat, fish, fruits, vegetables, etc.) up to 20 products. Included in prevailing European legislation on bovine traceability.

Food information

- W-010, W-010 B and W-015:
 - > Minimum letter size: 1.2 mm.
 - > For direct sale receipts and labels: possibility of indicating in the PLU name (with an * or other symbol) those that contain allergens and programming a text, such as "* Consult allergens".
 - > Labels do not comply with the labelling of packaged food Regulation (only 5 texts of 24 characters are available).



- W-020, W-020 B and W-025:
 - > Minimum letter size: 1.2 mm.
 - > Effect (**bold**, underlined, or **both**) for each character in the text (in W-025, only available under license of labelling of packaged food Regulation; see options).
 - > Possibility of using the general text "G" (2,048 characters) for ingredients, in lower case or UPPER CASE to highlight allergens (in W-025, only available under license of labelling of packaged food Regulation; see options).
 - > Possibility of including a table of nutritional facts.
 - > Free texts (10 x 24 characters).
 - > For direct sale receipts and labels: possibility of indicating in the PLU name (with an * or other symbol) those that contain allergens and programming a text, such as "* Consult allergens".
 - > Possibility of printing 2 labels for each operation: programmable by PLU, configurable information, 2nd automatic or manual label (also to be used as promotional labels). In W-025, only available under license of labelling of packaged food Regulation; see options.
- W-025: Compliance with EU Regulation 1169/2011 on the provision of food information to consumers as of 13 December 2016; see options.

Communications

- TCP/IP Ethernet for interconnection and connection to PC.
- RS-232, for connection to scanner (in W-020, W-020 B and W-025).

Security

- Access to different protected programming menus via configurable passwords.

Interconnection

- W-010, W-010 B and W-015: up to 5 scales per section
- W-020, W-020 B and W-025: up to 10 scales per section.

Connectivity with other devices

- PC.
- Barcode scanner (powered by the scale -5 VDC-) to read EAN-13 barcodes (in W-020, W-020 B and W-025).
- Cash drawer.

Software

(See section on software)

PC software:

- DFS:
 - > Programming of scales.
 - > Receipt of sales data.
 - > Data backup copy.
 - > Graphic design of receipts and labels (DLD).
 - > Design and management of advertising images for graphic display.
- Integration tools: in Windows or Linux to facilitate communication with the Back-Office.

Scale firmware:

- DWS (Dibal Web Server):
 - > Allows access to the information on each scale from any computer or mobile device with an Internet browser.

Power supply

- Mains: 110 up to 230 VAC.
- Depending on the models, also:
 - > High performance rechargeable internal battery (W-010 B and W-020 B): up to 36 hours of life (calculated for 1,000 receipts, with 3 articles per receipt)* and connector to external battery 12 V.

Energy consumption

- 6.5-91 W (depending on the conditions of use).

* With segment display and back lighting disconnected. The charging and autonomy times may vary considerably in accordance with the temperature, age and condition of the batteries, use of back lighting, frequency of use of the printer, interconnection, etc.

1 LABEL PRINTER (OR RECEIPT)

Flat
Format



Dimensions

DATA IN mm

A	365
B	440
C	160

Plate dimensions: L360 x W260 mm.
Weight with packaging: 10.0 kg.

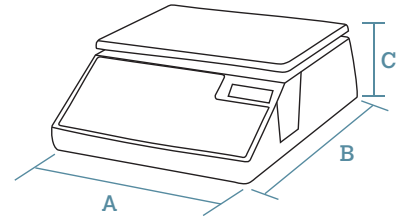

	Displays	Printer	PLUs	Direct PLUs	Vendors	Power	Capacity / Accuracy	Reference
W-015 F	LCD Segment	Labels (or Receipts)	2,000	45x2 +4x2*	5	Mains	6 kg / 2 g - 15 kg / 5 g	7W151PBLGE__
W-025 F	LCD Segment	Labels (or Receipts)	5,000	40x2 +9x2*	10	Mains	6 kg / 2 g - 15 kg / 5 g	7W251PBLGE__

M optional

* Using the Shift key and those of Vendor.

500 RANGE
ELECTRONIC SCALES

MISTRAL series





1 PRINTER
RECEIPTS
OR LABELS



LCD SEGMENT
DISPLAY



OPTIONAL LCD GRAPHIC
DISPLAY



UP TO 5,000 PLUs



UP TO 10 VENDORS



ETHERNET TCP/IP



WI-FI
OPTIONAL

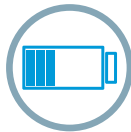

OPTIONAL RECHARGEABLE INTERNAL BATTERY



METROLOGICAL VERIFICATION
OPTIONAL (EU)

Characteristics and functionality

Main characteristics

- Electronic scale with higher visibility display options.
- Models with receipt printer or label printer (suitable for receipts).
- Variety of formats.
- Functional and robust design.
- Compliance with EU Regulation 1169/2011 on the provision of food information to consumers (only for M-525).

Features

- Extensive information for each PLU: normal price, price for weight scales and by kg/100 g (in M-520, M-520 B and M-525), 2 names of 20 characters (1 in M-510, M-510 B and M-515), 10 free texts of 24 characters (5 in M-510, M-510 B and M-515), 1 text of 3,000 characters (in M-525), etc.
- PLU search by code or name.
- Preset keys to programming menus: to change prices, register PLUs or vendors, etc.
- Direct access to 999 PLUs from the keyboard.
- Drill down menus.
- Printing of scale menus.
- 2 programmable macros (in M-520, M-520 B and M-525): recording of a sequence of keys to create direct access to

any task (reopening of receipts, lists, change in batcher number, etc.).

- Sales and management reports: sales (by article, vendor, time frames, last month, etc.), balance available in the cash drawer, modified PLUs, etc.
- Fast and reliable communication between scales, with PC and mobile devices (via DWS).
- Stocks management on the scale.
- Stock / order mode.

Capacity / Accuracy

- Multi-range (3,000 divisions): 6 kg / 2 g - 15 kg / 5 g.
- Optional:
 - > Mono-range (3,000 divisions): 15 kg / 5 g or 30 kg / 10 g.
 - > Multi-range (3,000 divisions): 15 kg / 5 g - 30 kg / 10 g.
 - > Mono-range (6,000 divisions): 12 kg / 2 g or 30 kg / 5 g.

Available formats

- Flat.
- Pole.
- Double body.
- Hanging (ABS or stainless steel).
- Self-service.

Construction

- Highly resistant ABS plastic casing in counter and hanging formats.
- Stainless steel casing in hanging format.
- Stainless steel plate.
- Access to all non-metrological components without the need to unseal the scale.

Displays

- Backlit LCD segment display (W150.2 X H43.4 mm) for vendor and buyer (showing weight, price / kg, total, tare, vendor and name of articles).
- Optional:
 - > LCD matrix graphic display (W134 x H41 mm) for vendor and buyer, for M-520, M-520 B and M-525. Possibility of showing: logos, profitability codes and warning messages sent from a PC (on vendor display) and advertising messages with animated effects on buyer display.

Printer

- Models available with 1 printer for receipts or 1 printer for labels (also suitable for receipts by changing the paper roll and the working mode).
- 54 mm thermal printer.
- Resolution: 8 dots/mm.
- Speed depending on models:
 - > M-520 and M-525: 100 mm/sec.
 - > M-510 and M-515: 80 mm/sec.
 - > M-510 B and M-520 B: 60 mm/sec.
- Cassette for immediate paper roll change (in label printers).
- Optional:
 - > Linerless (in M-525).

Receipts

- All the models:
 - > 15 fonts (6 monospaced + 9 multispaced: more modern and legible).
 - > Up to 40 items.
 - > EAN-13 barcode.
 - > 9 payment methods.
 - > Total in National currency and another 3 different currencies.
 - > Discounts per line and total.



- M-510, M-510 B and M-515:
 - > 2 fixed formats.
- M-520, M-520 B and M-525:
 - > 2 fixed formats + 1 programmable format.
 - > 4 logos per receipt.
 - > Name of vendor.
 - > Customers on account.

Labels

- All the models:
 - > 15 fonts (6 monospaced + 9 multispaced: more modern and legible).
 - > 40 logos.
 - > EAN-13 barcode.
 - > 40 fields of information.
 - > 100 programmable texts.
 - > Manual and automatic pre-packing modes.
 - > Automatic adjustment of the paper detection sensor.
- M-515:
 - > From W30 x L30 mm to W60 x L80 mm.
 - > 20 fixed formats + 5 programmable formats.
 - > 1 type of generic traceability (for meat, fish, fruits, vegetables, etc.) up to 10 products. Included in the prevailing European legislation on bovine traceability.
- M-525:
 - > From W30 x L30 mm to W60 x L100 mm.
 - > 20 fixed formats + 10 programmable formats.
 - > 3 levels of totals.
 - > Printing of "n" identical labels.
 - > Printing with 90°, 180° and 270° rotation.
 - > Packaging date, expiry date and extra date (for any application).
 - > Alphanumeric batch number.
 - > 2 types of generic traceability (for meat, fish, fruits, vegetables, etc.) up to 20 products. Included in the prevailing European legislation on bovine traceability.



Food information

- M-510, M-510 B and M-515:
 - > Minimum letter size: 1.2 mm.
 - > For direct sale receipts and labels: possibility of indicating in the PLU name (with an * or other symbol) those that contain allergens and programming a text, such as "* Consult allergens".
 - > Labels do not comply with the labelling packed food Regulation (only 5 texts of 24 characters are available).
- M-520, M-520 B and M-525:
 - > Minimum letter size: 1.2 mm.
 - > Effect (**bold**, underlined, or **both**) for each character in the text.
 - > Possibility of using the general text "G" (3,000 characters) for ingredients, in lower case or UPPER CASE to highlight allergens.
 - > Possibility of including a table of nutritional facts.
 - > Free texts (10 x 24 characters).
 - > For direct sale receipts and labels: possibility of indicating in the PLU name (with an * or other symbol) those that contain allergens and programming a text, such as "* Consult allergens".
 - > Possibility of printing 2 labels for each operation: programmable by PLU, configurable information, 2nd automatic or manual label (also to be used as promotional labels).
- M-525: Compliance with EU Regulation 1169/2011 on the provision of food information to consumers as of 13 December 2016.

Communications

- TCP/IP Ethernet for interconnection and connection to PC.
- RS-232, for connection to scanner (in M-520, M-520 B and M-525).
- Optional: Wi-Fi.

Security

- Access to different protected programming menus via configurable passwords.

Interconnection

- M-510, M-510 B and M-515: up to 5 scales per section.
- M-520, M-520 B and M-525: up to 10 scales per section.

Connectivity with other devices

- PC.
- Barcode scanner (powered by the scale -5 VDC-) to read EAN-13 bar codes (in M-520, M-520 B and M-525).
Optional built-in scanner, for double body format.
- Cash drawer.
- Queueing system (for hanging scales).
- Connectable to a single load cell weighing platform, up to 400 x 400 mm max., and up to 30 kg. Consult compatible scales formats.

Software

(See section on software)

PC software:

- DFS:
 - > Programming of scales.
 - > Receipt of sales data.
 - > Data backup copy.
 - > Graphic design of receipts and labels (DLD).
 - > Design and management of advertising images for graphic display.
- Integration tools: in Windows or Linux to facilitate communication with the Back-Office.

Scale firmware:

- DWS (Dibal Web Server):
 - > Allows access to the information on each scale from any computer or mobile device with an Internet browser.

Power supply

- Mains: 110 up to 230 VAC.
- Depending on the models, also:
 - > High performance rechargeable internal battery (M-510 B and M-520 B): up to 52 hours of life (calculated for 1,500 receipts, with 3 articles per receipt)* and connector to external battery 12 V.
 - > Optional: Anti-blackout rechargeable internal battery 24 V and connector to external battery 24 V.

Energy consumption

- 6.5-91 W (depending on the conditions of use).

* With segment display and back lighting disconnected. The charging and autonomy times may vary considerably in accordance with the temperature, age and condition of the batteries, use of back lighting, frequency of use of the printer, interconnection, etc.

1 LABEL PRINTER (OR RECEIPT)

Double Body Format



Cassette included.



Dimensions

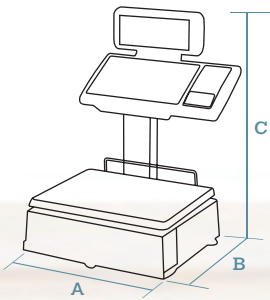

DATA IN mm

- A** 375
- B** 470
- C** 547

Plate dimensions:
L360 x W280 mm.
Weight with packaging: 15.0 kg.

	Displays	Printer	PLUs	Direct PLUs	Vendors	Power	Capacity / Accuracy	Reference
M-515 DB	LCD Segment	Labels (or Receipts)	2,000	45x2 +4x2*	5	Mains	6 kg / 2 g -15 kg / 5 g	7M151D2LGE__
M-525 DB	LCD Segment	Labels (or Receipts)	5,000	70x2 +9x2*	10	Mains	6 kg / 2 g -15 kg / 5 g	7M251D2LGE__

M optional

* Using the Shift key and those of Vendor.

1 LABEL PRINTER (OR RECEIPT)

S. Steel Hanging Format



Dimensions

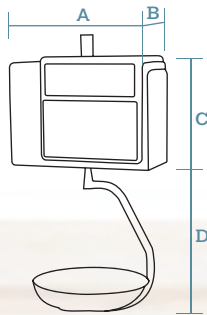

Cassette included.

DATA IN mm

- A** 400

- B** 186

- C** 300

- D** 415

Plate dimensions: Ø 310 mm.
Weight with packaging: 14.0 kg.

	Displays	Printer	PLUs	Direct PLUs	Vendors	Power	Capacity / Accuracy	Reference
M-515 H S. Steel	LCD Segment	Labels (or Receipts)	2,000	45x2 +4x2*	5	Mains	6 kg / 2 g -15 kg / 5 g	7M151C2SIE_
M-525 H S. Steel	LCD Segment	Labels (or Receipts)	5,000	70x2 +9x2*	10	Mains	6 kg / 2 g -15 kg / 5 g	7M251C2SIE_

M optional

* Using the Shift key and those of Vendor.

500 RANGE
ELECTRONIC SCALES

STAR series





1 or 2 PRINTERS
RECEIPTS, LABELS OR
RECEIPTS+LABELS



LCD SEGMENT
DISPLAY
(EXCEPT STAR COLOUR)



OPTIONAL LCD GRAPHIC
DISPLAY
(EXCEPT STAR COLOUR)



DUAL 7" TFT DISPLAY
(IN STAR COLOUR)



UP TO 10,000 PLUs



UP TO 20 VENDORS

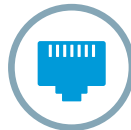

ETHERNET TCP/IP



USB



WI-FI
OPTIONAL

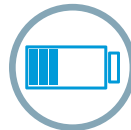

OPTIONAL RECHARGEABLE INTERNAL BATTERY
(EXCEPT STAR COLOUR)



METROLOGICAL VERIFICATION
OPTIONAL (EU)

Characteristics and functionality

Main characteristics

- Electronic scale with higher visibility display options.
- Models with receipt printer, label printer (suitable for receipts) or two printers (for receipts and labels).
- Variety of formats.
- Functional and robust design.
- Greater capacity (memory, functions, communications and interconnections).
- Compliance with EU Regulation 1169/2011 on the provision of food information to consumers.

Features

- Extensive information for each PLU: normal price and offer price, price for weight scales and by kg/100 g, 3 names of 20 characters or 2 names of 30 characters, 20 free texts of 24 characters, 1 text of 3,072 characters (in S-545 and S-547), etc.
- PLU search by code or name.
- Preset keys to programming menus: to change prices, register PLUs or vendors, etc.
- Direct access to 999 PLUs from the keyboard.
- Drill down menus.

- Printing of the scale menus.
- Programmable macros: recording of a sequence of keys to create direct access to any task (reopening of receipt, lists, change in batcher number, etc.). Depending on the model, the Star Series scales have macros and preset PLU keys, in addition to 10 specific macro keys.
- Sales and management reports: sales (by article, vendor, time frames, last month, etc.), margins, balance available in the cash drawer, modified PLUs, etc.
- Fast and reliable communication between scales, with PC and mobile devices (via DWS).
- Stocks management on the scale.
- Option to record normal price and offer price for each article.
- Stock / order mode.

Capacity / Accuracy

- Multi-range (3,000 divisions): 6 kg / 2 g - 15 kg / 5 g.
- Optional:
 - > Mono-range (3,000 divisions): 15 kg / 5 g or 30 kg / 10 g.
 - > Multi-range (3,000 divisions): 15 kg / 5 g - 30 kg / 10 g.
 - > Mono-range (6,000 divisions): 12 kg / 2 g or 30 kg / 5 g.

Available formats

- Flat (except Star Colour).
- Pole.
- Double body.
- Hanging (ABS or stainless steel).
- Self-service (except Star Colour).

Construction

- Highly resistant ABS plastic casing in counter and hanging formats.
- Stainless steel casing in hanging format.
- Stainless steel plate.
- Access to all non-metrological components without the need to unseal the scale.

Displays

- Backlit LCD segment display (W150.2 x H43.4 mm) for vendor and buyer (showing weight, price/ kg, total, tare, vendors and name of article).
- Optional:
 - > LCD matrix graphic display (W134 x H41 mm or W188 x H55 mm) for vendor and buyer. Possibility of showing: logos, profitability codes and warning messages sent from a PC (on vendor display) and advertising messages with animated effects on buyer display.
- Star Colour Models:
 - > 7" TFT display for vendor and buyer (shows advertising and promotional images even during sales operations).

Printer(s)

- Models available with 1 printer for receipts, 1 printer for labels (also suitable for receipts by changing the paper roll and the working mode) or 2 printers (for receipts and for labels).
- 54 mm thermal printer.
- Resolution: 8 dots/mm; speed: 100 mm/sec.
- Cassette for immediate paper roll change (in label printers).
- Optional:
 - > Linerless (in label printers).

Receipts

- 15 fonts (6 monospaced + 9 multispaced: more modern and legible).
- Up to 75 items.
- 2 fixed formats + 2 programmable formats.
- 4 logos per receipt.
- Barcodes: EAN-13, EAN-128 and Code 128*.
- Name of vendor.
- 9 payment methods.
- Total in National currency and another 3 currencies.
- Discounts per line and total.

- Loyalty points.
- Customers on account.
- Recipes.

Labels

- 15 fonts (6 monospaced + 9 multispaced: more modern and legible).
- From W30 x L30 mm to W60 x L150 mm.
- 20 fixed formats + 40 programmable formats.
- 100 logos.
- Barcodes: EAN-13, EAN-128 and Code 128*.
- 60 fields of information.
- 100 programmable texts.
- Manual and automatic pre-packing modes.
- 3 levels of totals.
- Printing of "n" identical labels.
- Printing with 90°, 180° and 270° rotation.
- Automatic adjustment of the paper detection sensor.
- Packaging date, expiry date and extra date (for any application).
- Alphanumeric batch number.
- 10 types of generic traceability (for meat, fish, fruit, vegetables, etc.) up to 99 products. Included in the prevailing European legislation on bovine traceability.



* It prints the following barcodes: EAN-13, EAN-128 and Code 128; it reads the following barcodes: EAN-13 and EAN-128.

Food information

- Compliance with EU Regulation 1169/2011 on the provision of food information to consumers as of 13 December 2016:
 - > Minimum letter size: 1.2 mm.
 - > Effect (**bold**, underlined or **both**) for each character in the text.
 - > Possibility of using the general text "G" (3,000 characters) for ingredients, in lower case or UPPER CASE to highlight allergens.
 - > Possibility of including a table of nutritional facts.
 - > Free texts (20 x 24 characters).
 - > For direct sale receipts and labels: possibility of indicating in the PLU name (with an * or other symbol) those that contain allergens and programming a text, such as "* Consult allergens".
 - > Possibility of printing 2 labels for each operation: programmable by PLU, configurable information, 2nd automatic or manual label (also to be used as promotional labels).

Communications

- TCP/IP Ethernet for interconnection and connection to PC.
- RS-232, for connection to scanner.
- USB.
- Optional:
 - > Wi-Fi.

Security

- Access to different protected programming menus via configurable passwords.

Interconnection

- Up to 16 scales per section.

Connectivity with other devices

- PC.
- Barcode scanner (powered by the scale -5 VDC-) to read EAN-13 and EAN-128 barcodes. Optional built-in scanner, for double body format.

- Cash drawer.
- Queueing system (for hanging scales).
- Connectable to a single load cell weighing platform, up to 400 x 400 mm max., and up to 30 kg. Consult compatible scales formats.

Software

(See section on software)

PC Software:

- DFS:
 - > Programming of scales.
 - > Receipt of sales data.
 - > Data backup copy.
 - > Graphic design of receipts and labels (DLD).
 - > Design and management of advertising images for graphic display and colour TFT.
- Integration tools: in Windows or Linux to facilitate communication with the Back-Office.

Scale firmware:

- DWS (Dibal Web Server):
 - > Allows access to the information on each scale from any computer or mobile device with an Internet browser.

Power supply

- Mains: 110 up to 230 VAC.
- Optional:
 - > High performance rechargeable internal battery (S-540 B DB): up to 52 hours of life (calculated for 1,500 receipts, with 3 articles per receipt)* and connector to external battery 12 V.
 - > Anti-blackout rechargeable internal battery 24 V and connector to external battery 24 V.

Energy consumption

- Star: 6.5-91 W (depending on the conditions of use).
- Star Colour: 8.5-93 W (depending on the conditions of use).

* With segment display and back lighting disconnected. The charging and autonomy times may vary considerably in accordance with the temperature, age and condition of the batteries, use of back lighting, frequency of use of the printer, interconnection, etc.

1 LABEL PRINTER (OR RECEIPT)

Flat
Format



Dimensions

DATA IN mm

A	382
B	481
C	180

Plate dimensions: L360 x W260 mm.
Weight with packaging: 11.7 kg.

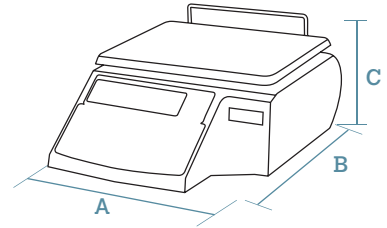

Cassette included.



	Displays	Printer	PLUs	Direct PLUs	Vendors	Power	Capacity / Accuracy	Reference
S-545 F	LCD Segment	Labels (or Receipts)	10,000	30x2 +19x2*	20	Mains	6 kg / 2 g - 15 kg / 5 g	7S451P5LGE__

M optional

* Using the Shift key and those of Vendor.

1 LABEL PRINTER (OR RECEIPT)

S. Steel Hanging Format



Dimensions

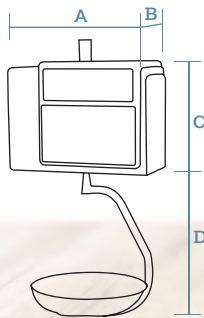

DATA IN mm

- A** 400
- B** 186
- C** 300
- D** 415

Plate dimensions: Ø 310 mm.
Weight with packaging: 14.0 kg.



Cassette included.

	Displays	Printer	PLUs	Direct PLUs	Vendors	Power	Capacity / Accuracy	Reference
S-545 H S. Steel	LCD Segment	Labels (or Receipts)	10,000	60x2 +19x2*	20	Mains	6 kg / 2 g -15 kg / 5 g	7S451C5SIE__

M optional

* Using the Shift key and those of Vendor.

2 PRINTERS (RECEIPTS AND LABELS)

Double Body Format



Cassette included.



Dimensions

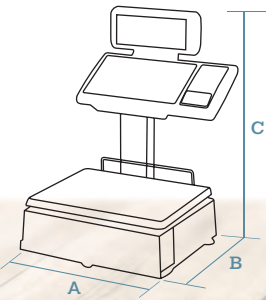

DATA IN mm

- A** 375
- B** 470
- C** 547

Plate dimensions:
L360 x W280 mm.
Weight with packaging: 13.0 kg.

	Displays	Printers	PLUs	Direct PLUs	Vendors	Power	Capacity / Accuracy	Reference
S-547 DB	LCD Segment	1 Receipt printer + 1 Label printer	10,000	60x2 +19x2*	20	Mains	6 kg / 2 g -15 kg / 5 g	7S471D5LGE__

(M) optional

* Using the Shift key and those of Vendor.

2 PRINTERS (RECEIPTS AND LABELS)

S. Steel Hanging Format



Dimensions

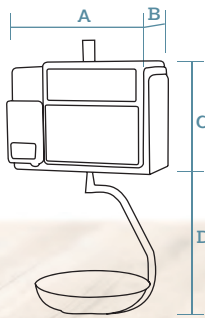

DATA IN mm

- A** 408
- B** 186
- C** 300
- D** 415

Plate dimensions: Ø 310 mm.
Weight with packaging: 14.0 kg.



Cassette included.



	Displays	Printers	PLUs	Direct PLUs	Vendors	Power	Capacity / Accuracy	Reference
S-547 H S. Steel	LCD Segment	1 Receipt printer + 1 Label printer	10,000	60x2 + 19x2*	20	Mains	6 kg / 2 g - 15 kg / 5 g	7S471C5SIE__

M optional

* Using the Shift key and those of Vendor.

Accessories



Ref: BCR73

Small Italian plate

L357 x W235 x H55 mm.



Ref: BCR74

Large Italian plate

L407 x W284 x H60 mm.



Ref: BU-C1229

Flat plate for hanging scales

L360 x W280 mm, instead of the semi deep plate.



Ref: BC-C039

Deep plate for hanging scales

Ø310 x H70 mm, instead of the semi deep plate.



Ref: BHN99

Interconnection switch

For S-540 B DB scales with rechargeable internal battery.



Ref: BHN85

Battery for the switch

Power battery for the BHN99 interconnection switch.

TOUCH SCREEN
ELECTRONIC SCALE

D-900 series





1 or 2 PRINTERS
RECEIPTS, LABELS OR
RECEIPTS+LABELS



**TOUCH
SCREEN**
TFT



UP TO
10,000 PLUs



UP TO
20 VENDORS

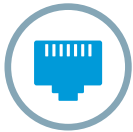

ETHERNET
TCP/IP



USB



WI-FI
OPTIONAL



**METROLOGICAL
VERIFICATION**
OPTIONAL (EU)

Characteristics and functionality

Main characteristics

- Touch screen scale with conventional electronics (no PC).
- Models with receipt printer, label printer (suitable for receipts) or with 2 printers (for receipts and labels).
- Variety of formats.
- Modern, compact and easy to clean design.
- More intuitive user menus.
- More dynamic and stylish buyer screen as an advertising tool.
- Configurable and customized flat vendor screen.
- Compliance with EU Regulation 1169/2011 on the provision of food information to consumers.

Features

- Extensive information for each PLU: normal price and offer price, price for weight ranges and by kg/100 g, 3 names of 20 characters or 2 names of 30 characters, 20 free texts of 24 characters, 1 text of 3,000 characters (in D-955 and D-957), etc.
- PLUs search by codes or name.
- Access to all functions of the user and technical menus from the vendor screen (possibility of programming security passwords).

- Customization of the screens:
 - > Selection of the most frequent functions in "Favourites".
 - > Screen design with corporate colours and logos.
 - > Allocation of independent direct keys by section and alphabetic order of the PLUs.
 - > Preset keys for PLUs, sections and vendors, whereby the image, quantity and size can be configured.
- Direct uploading of images from pen drive (8 bits bmp format without RLE compression).
- Sales and management reports: sales (by article, vendor, time frames, last month, etc.), margins, balance available in the cash drawer, modified PLUs, etc.
- Export of lists to USB (total sales per employee, per payment method, per VAT rate).
- Export of receipts to USB.
- Cross selling: showing the picture of a complementary product on buyer display when selling a product.
- Fast and reliable communication between scales, with PC and mobile devices (via DWS).
- Stock management by article on the scale.
- Option to record normal price and offer price for each article.
- Warning of low level of labels in the scale, and activating light and acoustic signs.

Capacity / Accuracy

- Multi-range (3,000 divisions): 6 kg / 2 g - 15 kg / 5 g.
- Optional:
 - > Mono-range (3,000 divisions): 15 kg / 5 g or 30 kg / 10 g.
 - > Multi-range (3,000 divisions): 15 kg / 5 g - 30 kg / 10 g.
 - > Mono-range (6,000 divisions): 12 kg / 2 g or 30 kg / 5 g.

Available formats

- Flat.
- Pole.
- Double body.
- Hanging.
- Self-service.

Construction

- Highly resistant ABS plastic casing in counter format.
- Stainless steel casing in hanging formats.
- Stainless steel plate.
- Access to all non-metrological components without the need to unseal the scale.

Displays

- Vendor: Configurable 12.1" touch screen TFT in double body, hanging and self-service formats (W250 x H188 mm); 10.4" in flat, pole and flat self-service formats (W215 x H161 mm) and 15" in double body self-service format.
- Buyer: 7" TFT (W191 x H122 mm) with adjustable inclination, or 12.1" TFT (with adjustable inclination and height). Allows showing advertising or promotional images even during the selling operation; or the turn (managed from the scale).

Printer(s)

- Models available with 1 printer for receipts, 1 printer for labels (also suitable for receipts by changing the paper roll and the working mode) or with 2 printers (for receipts and labels).
- 54 mm thermal printer.
- Resolution: 8 dots/mm; speed: 100 mm/sec.
- Cassette for immediate paper roll change (in label printers).
- Optional:
 - > Linerless (in label printers).

Receipts

- 15 fonts (6 monospaced + 9 multispaced: more modern and legible).
- Up to 75 items.
- 2 fixed formats + 2 programmable formats.
- 4 logos.
- Barcodes: EAN-13, GS1 DataBar, EAN-128, Code 128 and QR.*
 - > Possibility of printing QR codes, for example, for ticket breakdown.
- Name of vendor.



- 9 payment methods.
- Total in National currency and other 3 currencies.
- Discounts per line and total.
- Loyalty points.
- Customers on account.
- Recipes.

Labels

- 15 fonts (6 monospaced + 9 multispaced: more modern and legible).
- From W30 x L30 mm to W60 x L150 mm.
- 20 fixed formats + 40 programmable formats.
- 100 logos.
- Barcodes: EAN-13, GS1 DataBar, EAN-128, Code 128 and QR.*
 - > Possibility of printing QR codes, for example, for ticket breakdown.
- 60 fields of information.
- 100 programmable texts.
- Manual and automatic pre-packing modes.
- 3 levels of totals.
- Printing of "n" identical labels.
- Printing with 90°, 180° and 270° rotation.
- Automatic adjustment of the paper detection s
- Packaging date, expiry date and extra date (for any application).
- Alphanumeric batch number.
- 10 types of generic traceability (for meat, fish, fruits, vegetables, etc.) up to 99 products. Included in the prevailing European legislation on bovine traceability.



* It prints the following barcodes: EAN-13, GS1 DataBar, EAN-128, Code 128 and QR; it reads the following barcodes: EAN-13, EAN-128 and QR.

Food information

- Compliance with EU Regulation 1169/2011 on the provision of food information to consumers as of 13 December 2016:
 - > Minimum letter size: 1.2 mm.
 - > Effect (**bold**, underlined, or **both**) for each character in the text.
 - > Possibility of using the general text "G" (3,000 characters) for ingredients, in lower case or UPPER CASE to highlight allergens.
 - > Possibility of including a table of nutritional facts.
 - > Free texts (20 x 24 characters).
 - > For direct sale receipts and labels: possibility of indicating in the PLU name (with an * or other symbol) those that contain allergens and programming a text, such as "* Consult allergens".
 - > Possibility of printing 2 labels for each operation: programmable by PLU, configurable information, 2nd automatic or manual label (also to be used as promotional labels).

Communications

- TCP/IP Ethernet for interconnection and connection to PC.
- RS-232, for connection to scanner.
- USB.
- Optional:
 - > Wi-Fi.

Security

- Access to different protected programming menus via configurable passwords.

Interconnection

- Up to 16 scales per section.

Connectivity with other devices

- PC.
- Barcode scanner (powered by the scale -5 VDC-) to read EAN-13, EAN-128 and QR barcodes. Optional built-in scanner, for double body format.
- Cash drawer.
- Queueing system (for hanging scales).
- Connectable to a single load cell weighing platform, up to 400 x 400 mm max., and up to 30 kg. Consult compatible scales formats.

Software

(See section on software)

PC software:

- DFS:
 - > Programming of scales.
 - > Receipt of sales data.
 - > Data backup copy.
 - > Graphic design of receipts and labels (DLD).
 - > Design and management of advertising images for buyer display.
- Integration tools: in Windows or Linux to facilitate communication with the Back-Office.

Scale firmware:

- DWS (Dibal Web Server):
 - > Allows access to the information on each scale (via passwords) from any computer or mobile device with an Internet browser.

Power supply

- Mains: 110 up to 230 VAC.
- Optional:
 - > Anti-blackout rechargeable internal battery 24 V and connector to external battery 24 V.

Energy consumption

- 16.5-90 W (depending on the conditions of use).

1 LABEL PRINTER (OR RECEIPT)

Flat
Format



Dimensions

DATA IN mm

A	382
B	520
C	180

Plate dimensions: L360 x W260 mm.
Weight with packaging: 12.5 kg.

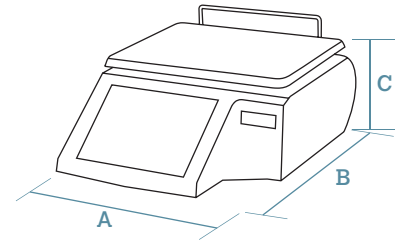

Cassette included.



	Vendor Display	Buyer Display	Printer	PLUs	Direct PLUs	Vendors	Power	Capacity / Accuracy	Reference
D-955 F 10 + 7	10.4" touch screen TFT	7" TFT	Labels (or Receipts)	10,000	999	20	Mains	6 kg / 2 g - 15 kg / 5 g	7D755P5LGE_ _

M optional

1 LABEL PRINTER (OR RECEIPT)

Double Body Format



Dimensions

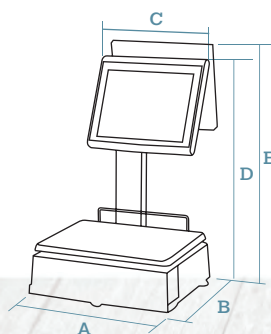

Cassette included.

DATA IN mm

- A** 375
- B** 470
- C** 305
- D** 600
- E** 640-730 (adjustable)

Plate dimensions:
L360 x W280 mm.

Weight with packaging: 21.0 kg.



	Vendor Display	Buyer Display	Printer	PLUs	Direct PLUs	Vendors	Power	Capacity / Accuracy	Reference
D-955 DB 12 + 7	12.1" touch screen TFT	7" TFT	Labels (or Receipts)	10,000	999	20	Mains	6 kg / 2 g - 15 kg / 5 g	7D755D5LGE_
D-955 DB 12 + 12	12.1" touch screen TFT	12.1" TFT	Labels (or Receipts)	10,000	999	20	Mains	6 kg / 2 g - 15 kg / 5 g	7D756D5LGE_

M optional

1 LABEL PRINTER (OR RECEIPT)

S. Steel Hanging Format



Dimensions

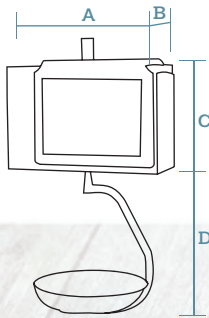

Cassette included.

DATA IN mm

- A** 436
- B** 126
- C** 300
- D** 415

Plate dimensions: Ø 310 mm.
Weight with packaging: 13.0 kg.

	Vendor Display	Buyer Display	Printer	PLUs	Direct PLUs	Vendors	Power	Capacity / Accuracy	Reference
D-955 H 12 + 7	12.1" touch screen TFT	7" TFT	Labels (or Receipts)	10,000	999	20	Mains	6 kg / 2 g - 15 kg / 5 g	7D755C5SIE__
D-955 H 12 + 12	12.1" touch screen TFT	12.1" TFT	Labels (or Receipts)	10,000	999	20	Mains	6 kg / 2 g - 15 kg / 5 g	7D756C5SIE__

M optional

2 PRINTERS (RECEIPTS AND LABELS)

Double Body Format



Dimensions

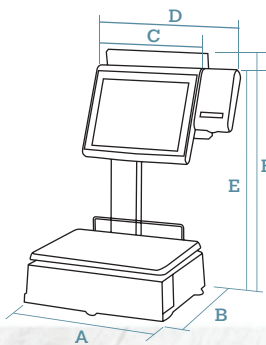

Cassette included.

DATA IN mm

- A** 375
- B** 470
- C** 305
- D** 405
- E** 600
- F** 640-730 [adjustable]

Plate dimensions:
L360 x W280 mm.
Weight with packaging: 22.0 kg.

	Vendor Display	Buyer Display	Printers	PLUs	Direct PLUs	Vendors	Power	Capacity / Accuracy	Reference
D-957 DB 12 + 7	12.1" touch screen TFT	7" TFT	1 Receipt printer + 1 Label printer	10,000	999	20	Mains	6 kg / 2 g -15 kg / 5 g	7D775D5LGE__
D-957 DB 12 + 12	12.1" touch screen TFT	12.1" TFT	1 Receipt printer + 1 Label printer	10,000	999	20	Mains	6 kg / 2 g -15 kg / 5 g	7D776D5LGE__

M optional

2 PRINTERS (RECEIPTS AND LABELS)

S. Steel Hanging Format



Dimensions

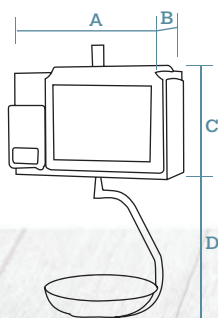

Cassette included.

DATA IN mm

- A** 443
- B** 186
- C** 300
- D** 415

Plate dimensions: Ø 310 mm.
Weight with packaging: 13.5 kg.

	Vendor Display	Buyer Display	Printers	PLUs	Direct PLUs	Vendors	Power	Capacity / Accuracy	Reference
D-957 H 12 + 7	12.1" touch screen TFT	7" TFT	1 Receipt printer + 1 Label printer	10,000	999	20	Mains	6 kg / 2 g - 15 kg / 5 g	7D775C5SIE_
D-957 H 12 + 12	12.1" touch screen TFT	12.1" TFT	1 Receipt printer + 1 Label printer	10,000	999	20	Mains	6 kg / 2 g - 15 kg / 5 g	7D776C5SIE_

M optional

Options



> Built-in scanner in scale

Option	Characteristics	Ref.
Capacity 15 kg / 5 g	Mono-range (3,000 divisions).	...N__ (*)
Capacity 30 kg / 10 g	Mono-range (3,000 divisions).	...Y__ (*)
Capacity 15 kg / 5 g - 30 kg / 10 g	Multi-range (3,000 divisions).	...F__ (*)
Capacity 12 kg / 2 g	Mono-range (6,000 divisions).	...V__ (*)
Capacity 30 kg / 5 g	Mono-range (6,000 divisions).	...P__ (*)
Linerless	Label or receipt on continuous adhesive paper without supporting paper (in label printers: D-955 and D-957).	Consult
Wi-Fi	Wireless communications (IEEE 802.11n).	Consult
Anti-blackout	Anti-blackout internal battery 24 V + external battery connector 24 V.	Consult
Built-in scanner in the scale	1D and 2D barcodes. Only for double body format.	Consult
DFS Software	Scale configuration, receipt of sales data for processing with other IT applications, data backup (LBS), and labels and receipts graphic design (DLD). (See section on software).	7340F1U1
		7340FNU1
		7340D1U1
		7340DNU1
Technical DWS Firmware	For the remote configuration of the scale.	7340W101
Full DWS Firmware	For the remote configuration of the scale and processing of the information generated. (See section on software).	7340WN01
Metrological verification (M)	According to EU weighing directives (See section on equipment metrological verification).	Consult

(*) The scale references with this capacity are obtained by replacing the last characters of the reference for the standard scale with the indicated ending.

Accessories



Ref: BCR73

Small Italian plate

L357 x W235 x H55 mm.



Ref: BCR74

Large Italian plate

L407 x W284 x H60 mm.



Ref: BU-C1229

Flat plate for hanging scales

L360 x W280 mm, instead of the semi deep plate.



Ref: BC-C039

Deep plate for hanging scales

Ø310 x H70 mm, instead of the semi deep plate.



Ref: BCH18

Barcode scanner

Includes connection cable to the scale. (For built-in scanner, consult options).



Ref: BL-P3623

Adapter for receipt printing in label printer

Required for standard size receipt rolls.

Note:

- The references correspond to standard models: Dark gray ABS plastic in counter format or stainless steel casing in hanging format, 15", 12.1" or 10.4" TFT touch screen in vendor side and 12.1" or 7" TFT display in buyer side (depending on format), stainless steel flat plate in counter scales (semi deep stainless steel plate in hanging scales), cash drawer connector (queueing system connector in hanging scales) and TCP/IP Ethernet communications. Capacity/Accuracy: 6 kg / 2 g - 15 kg / 5 g.

PC SCALES

CS-2100 series





1 PRINTER
RECEIPTS
OR LABELS



**LINERLESS +
AUTOCUTTER**
DEPENDING ON MODEL



**TOUCH
SCREEN
TFT**



WINDOWS 10



**LINUX
CONSULT**



**128 GB
SSD**



**UNLIMITED
PLUS**



**UNLIMITED
VENDORS**

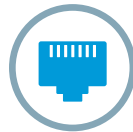

**ETHERNET
TCP/IP**



USB



**WI-FI
OPTIONAL**



**METROLOGICAL
VERIFICATION
OPTIONAL (EU)**

Characteristics and functionality

Main characteristics

- High performance retail PC based scale with double colour TFT (one in self-service format).
- Models with receipt printer or label printer (suitable for receipts).
- Variety of formats.
- Modern, compact and easy to clean design.
- Intuitive operation.
- Configurable and customizable vendor screen.
- More dynamic and stylish buyer screen as an advertising tool.
- Compliance with EU Regulation 1169/2011 on the provision of food information to consumers.

Features

- Open to run third parties Windows IT applications and ERP systems.
- Available functions with CS SERIES Windows software pre-installed:
 - > User screen design application (for assisted and self-service sales). Each user may have access to his/her own sales templates, which may be associated with previously defined access permissions.
 - > Wide range of templates for sales screens, articles database and food images (meat/butcher, fruits/vegetables, fish/shellfish, frozen food, drinks, etc.).

- > Modern, simple and intuitive operating screens that facilitate the use and improve the experience of the seller.
- > Cross-selling: showing the picture of a complementary product on buyer display when selling a product.
- > Library of images and videos included in the scale for promotional support.
- > Unlimited article keys [in consecutive screens].
- > All the keys can include texts, icons, pictures, etc.
- > Possibility of automatic ordering of the keys by different criteria: code, name, best sellers, etc.
- > Configurable keyboard by PLUs, sections, vendors, QWERTY or ABC keyboard, etc.
- > Quick access to register articles, sellers and sections.
- > Quick change of the document to be generated: delivery note, receipt or simplified invoice.
- > Optional display of the receipt or label on the screen.
- > Easy cancellation of receipt lines / easy reopening of receipt.
- > Easy cancellation of lines in receipts.
- > Printing of receipts and labels with Windows fonts.
- > Receipts and labels design.
- > Invoices and delivery notes design.
- > Pre-defined formats of labels, delivery notes and simplified invoices.
- > Document format associated with client.

- > Personalization of header and logos in simplified invoices.
- > Issue of invoices and delivery notes.
- > Billing of delivery notes.
- > Cash desk closing.
- > Generation of lists and graphs for total sales or broken down (by article, client, vendor, period, etc.) with three output options: on screen, via scale printer or via an external printer.
- > Stocks, clients and providers management in the scale.
- > Deletion of negative stocks.
- > Traceability management.
- > Option to record normal price and offer price for each article.
- > Price lists associated to each store or client.
- > Management of stock and article orders.
- > Data migration.
- > Backup.
- > The application runs automatically at start up.
- > Automatic opto adjustment.
- > Functions for point of sale secure cash payment system (under license).
- > Functions for electronic labels and plastic card labellers (under license).
- > Turnomatic in buyer display function (under license).
- > For integrated turn management system with digital signage solutions, consult (on request).

Capacity / Accuracy

- Multi-range (3,000 divisions): 6 kg / 2 g - 15 kg / 5 g.
- Optional:
 - > Mono-range (3,000 divisions): 15 kg / 5 g or 30 kg / 10 g.
 - > Multi-range (3,000 divisions): 15 kg / 5 g - 30 kg / 10 g.
 - > Mono-range (6,000 divisions): 12 kg / 2 g or 30 kg / 5 g.

Formats

- Flat.
- Double body.
- Hanging.
- Self-service.

Construction

- Highly resistant ABS plastic casing in counter formats.
- Stainless steel casing in hanging format.
- Stainless steel plate.
- Access to all non-metrological components without the need to unseal the scale.

Displays

- Vendor: fully configurable 12.1" resistive touch screen TFT in double body, hanging and self-service format (W250 x H188 mm); 10.4" projected capacitive TFT in flat and double body format (W215 x H161 mm); 15" resistive touch screen TFT in self-service format (W304 x H228 mm).
- Buyer: 7" (W191 x H122 mm) or 12.1" (W250 x H188 mm) TFT adjustable in height. Allows showing advertising or promotional images even during the selling operation (more than 250 images in the scale).

Printer(s)

- Models available with 1 printer for receipts or 1 printer for labels (also suitable for receipts by changing the paper roll and the working mode).
- 54 mm thermal printer.
- Resolution: 8 dots/mm; speed: 100 mm/sec.
- Cassette for immediate paper roll change in label printers.
- Linerless with autocutter in label printer, depending on format.
- Optional:
 - > Extra external printer for invoices, lists, etc.

Receipts

- Paper width from 30 mm to 60 mm.
- Unlimited items.
- Unlimited programmable formats.
- Unlimited logos.
- Windows fonts.
- Barcodes: EAN-13, EAN-128, Code 128, IFT-14 and QR.
- Name of vendor.
- VAT break down.
- Unlimited payment modes.
- Discounts per line and total.
- Offers: 3x2, 2nd unit discount, price per segment, free product, etc.
- Loyalty points.
- Customers on account.
- Stamps.
- Unlimited receipts.





Labels

- Paper width from 30 mm to 60 mm.
- Unlimited programmable formats.
- Unlimited logos.
- Windows fonts.
- Barcodes: EAN-13, EAN-128, Code 128, IFT-14 and QR.
- Unlimited information fields.
- Unlimited programmable texts.
- Unlimited headings per label.
- Manual and automatic pre-packing modes.
- 3 levels of totals.
- Printing of "n" identical labels.
- Printing with 90°, 180° and 270° rotation.
- Packaging date, expiry date, freezing date and extra date (for any application).
- Alphanumeric batch number.
- Unlimited types of generic traceability (for meat, fish, fruits, vegetables, etc.) and unlimited products. Included in the prevailing European legislation on bovine traceability.

Food information

- Compliance with EU Regulation 1169/2011 on the obligation to provide nutrition information to consumers as of 13 December 2016:
 - > Minimum letter size: 1.2 mm.
 - > Windows fonts.
 - > Effects: **bold**, underlined, or **any effect of a Windows font** for each character in the text.
 - > Possibility of using the general text "G" (21 x 64,000) for ingMainsients to highlight allergens with those effects and fonts.
 - > Programmable allergen table: automatically identifies allergens in the ingMainsient texts.
 - > For receipts, possibility of indicating in the PLU "name 2" of those that contain allergens "Consult allergens" (or PLU* + "*Contains allergens").
 - > Possibility of printing 2 labels for each operation: programmable by PLU, configurable information, 2nd automatic or manual label (to be used also as promotional labels).

CPU

- Processor: Intel Atom X5.
- Memory: 2 GB.
- Hard disk: 32 GB SSD.

Communications

- 1 USB (3.0) + 1 USB (2.0).
- 1 RS-232 (internal).
- 1 Ethernet.
- Optional:
 - > Wi-Fi.

Security

- Programmable access levels through user profiles.

Connectivity with other devices

- PC.
- Receipt of sales data from Dibal CS-2200 Series, 500 Range and D-900 Series scales, and CL-3 Series PC labellers.
- Windows printers.
- Barcode scanner (built-in scanner optional).
- Manual and automatic cash drawer.
- Queueing system (for hanging and double body formats).
- Other peripherals: keyboard, mouse, etc.
- Point of sale secure cash payment system.
- Connectable to a single load cell weighing platform, up to 400 x 400 mm max., and up to 30 kg. Consult compatible scales formats.

Software

- SW CS SERIES for Windows: touch application for sales, weighing management and labels and receipts design (DLD).
- Integration tools: in Windows or Linux to facilitate communication with the Back-Office.

Power supply

- Mains: 110 up to 230 VAC.

Energy consumption

- 29.6-90 W (depending on the conditions of use).

1 RECEIPT PRINTER 2"

Double Body Format



Dimensions

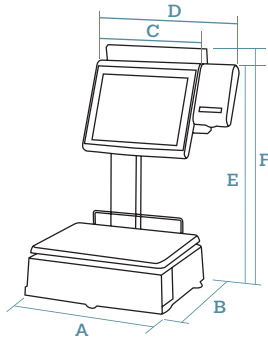

DATA IN mm

	10"	12"
A	380	380
B	385	385
C	265	305
D	380	405
E	505	600
F	505-570	640-730 (adjustable)

Plate dimensions:
L360 x W280 mm.
Weight with packaging: 21.0 kg.



	Vendor display	Buyer display	Printer	Operating system	Sales software	Power	Capacity/Accuracy	Reference
CS-2150 W DB 10 + 7	10" projected capacitive TFT touch screen	TFT 7"	2" Receipts	Windows 10 (embedded)	CS SERIES SW	Mains	6 kg / 2 g -15 kg / 5 g	7FA0SDALGE__
CS-2150 DB 12 + 7	12" resistive TFT touch screen	TFT 7"	2" Receipts	Windows 10 (embedded)	CS SERIES SW	Mains	6 kg / 2 g -15 kg / 5 g	7FA0LDALGE__
CS-2150 W DB 12 + 12	12" resistive TFT touch screen	TFT 12"	2" Receipts	Windows 10 (embedded)	CS SERIES SW	Mains	6 kg / 2 g -15 kg / 5 g	7FA0MDALGE__

M optional

1 RECEIPT PRINTER 2"

S. Steel Hanging Format



Dimensions

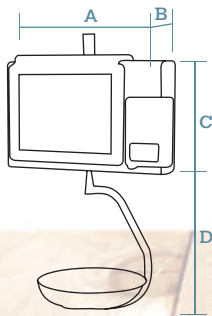

DATA IN mm

- A** 436
- B** 126
- C** 300
- D** 415

Plate dimensions: Ø 310 mm.
Weight with packaging: 11.0 kg.



	Vendor display	Buyer display	Printer	Operating system	Sales software	Power	Capacity/Accuracy	Reference
CS-2150 W H 12 + 7	12" resistive TFT touch screen	TFT 7"	2" Receipts	Windows 10 (embedded)	CS SERIES SW	Mains	6 kg / 2 g - 15 kg / 5 g	7FA0LCASIE__
CS-2150 W H 12 + 12	12" resistive TFT touch screen	TFT 12"	2" Receipts	Windows 10 (embedded)	CS SERIES SW	Mains	6 kg / 2 g - 15 kg / 5 g	7FA0MCASIE__

M optional

1 LABEL PRINTER (OR RECEIPT) 2"

Flat
Format



Dimensions

DATA IN mm

A	382
B	520
C	180

Plate dimensions: L360 x W260 mm.
Weight with packaging: 12.5 kg.

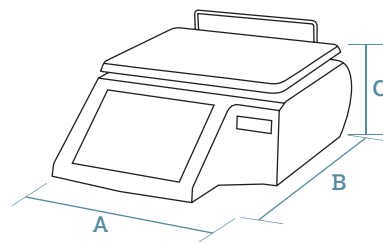

Cassette included.



	Vendor display	Buyer display	Printer	Operating system	Sales software	Power	Capacity/Accuracy	Reference
CS-2155 W F 10 + 7	10" projected capacitive TFT touch screen	TFT 7"	2" Labels (or Receipts)	Windows 10 (embedded)	CS SERIES SW	Mains	6 kg / 2 g -15 kg / 5 g	7FA5SPALGE__

M optional

1 LABEL PRINTER (OR RECEIPT) 2"

Double Body Format



Dimensions

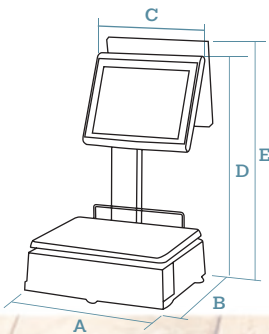

Cassette included.

DATA IN mm

	10"	12"
A	380	380
B	385	385
C	265	305
D	505	600
E	505-570	640-730 (adjustable)

Plate dimensions:
L360 x W280 mm.
Weight with packaging: 21.0 kg.



	Vendor display	Buyer display	Printer	Operating system	Sales software	Power	Capacity/Accuracy	Reference
CS-2155 W DB 10 + 7	10" projected capacitive TFT touch screen	TFT 7"	2" Labels (or Receipts)	Windows 10 (embedded)	CS SERIES SW	Mains	6 kg / 2 g - 15 kg / 5 g	7FA5SDALGE__
CS-2155 DB 12 + 7	12" resistive TFT touch screen	TFT 7"	2" Labels (or Receipts)	Windows 10 (embedded)	CS SERIES SW	Mains	6 kg / 2 g - 15 kg / 5 g	7FA5LDALGE__
CS-2155 W DB 12 + 12	12" resistive TFT touch screen	TFT 12"	2" Labels (or Receipts)	Windows 10 (embedded)	CS SERIES SW	Mains	6 kg / 2 g - 15 kg / 5 g	7FA5MDALGE__

M optional

1 LABEL PRINTER (OR RECEIPT) 2" LINERLESS WITH AUTOCUTTER

Double Body Format



Dimensions

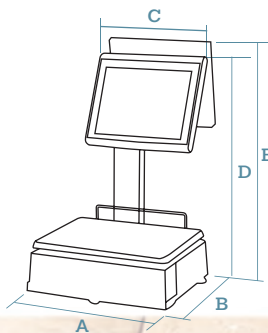

Cassette included.

DATA IN mm

	10"	12"
A	380	380
B	385	385
C	265	305
D	505	600
E	505-570	640-730 (adjustable)

Plate dimensions: L360 x W280 mm.
Weight with packaging: 21.0 kg.



	Vendor display	Buyer display	Printer	Operating system	Sales software	Power	Capacity/Accuracy	Reference
CS-2155 W DB 10+7	10" projected capacitive TFT touch screen	TFT 7"	2" Labels (or Receipts) linerless with autocutter	Windows 10 (embedded)	CS SERIES SW	Mains	6 kg / 2 g -15 kg / 5 g	7FANSDALGE__
CS-2155 W DB 12+7	12" resistive TFT touch screen	TFT 7"	2" Labels (or Receipts) linerless with autocutter	Windows 10 (embedded)	CS SERIES SW	Mains	6 kg / 2 g -15 kg / 5 g	7FANLDALGE__
CS-2155 W DB 12+12	12" resistive TFT touch screen	TFT 12"	2" Labels (or Receipts) linerless with autocutter	Windows 10 (embedded)	CS SERIES SW	Mains	6 kg / 2 g -15 kg / 5 g	7FANMDALGE__

1 LABEL PRINTER (OR RECEIPT) 2"

S. Steel Hanging Format



Dimensions

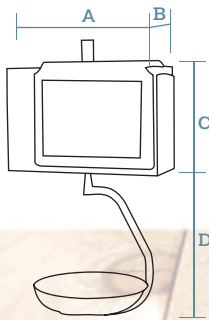

Cassette included.

DATA IN mm

- A** 436
- B** 126
- C** 300
- D** 415

Plate dimensions: Ø 310 mm.
Weight with packaging: 13.0 kg.



	Vendor display	Buyer display	Printer	Operating system	Sales software	Power	Capacity/Accuracy	Reference
CS-2155 W H 12 + 7	12" resistive TFT touch screen	TFT 7"	2" Labels (or Receipts)	Windows 10 (embedded)	CS SERIES SW	Mains	6 kg / 2 g - 15 kg / 5 g	7FA5LCASIE__
CS-2155 W H 12 + 12	12" resistive TFT touch screen	TFT 12"	2" Labels (or Receipts)	Windows 10 (embedded)	CS SERIES SW	Mains	6 kg / 2 g - 15 kg / 5 g	7FA5MCASIE__

M optional

PC SCALES

CS-2200 series



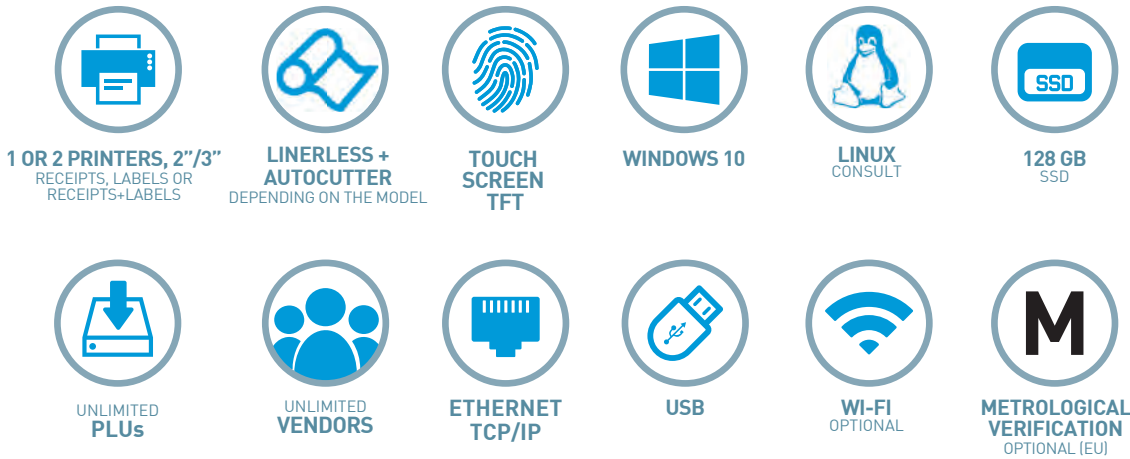

Characteristics and functionality

Main characteristics

- High performance retail PC based scale with double colour TFT (one in self-service format).
- Models with receipt printer, label printer (suitable for receipts, depending on the model) or with 2 printers (for receipts and labels).
- Printers of 2" or 3", depending on the format.
- Variety of formats.
- Modern, compact and easy to clean design.
- Intuitive operation.
- Configurable and customizable vendor screen.
- More dynamic and stylish buyer screen as an advertising tool.
- Compliance with EU Regulation 1169/2011 on the provision of food information to consumers.

Features

- Open to run third parties Windows IT applications and ERP systems.
- Available functions with CS SERIES Windows software pre-installed:
 - > User screen design application (for assisted and self-service sales). Each user may have access to his/her own sales templates, which may be associated with previously defined access permissions.

- > Wide range of templates for sales screens, articles database and food images (meat/butcher, fruits/vegetables, fish/shellfish, frozen food, drinks, etc.).
- > Modern, simple and intuitive operating screens that facilitate the use and improve the experience of the seller.
- > Cross-selling: showing the picture of a complementary product on buyer display when selling a product.
- > Library of images and videos included in the scale for promotional support.
- > Unlimited article keys (in consecutive screens).
- > All the keys can include texts, icons, pictures, etc.
- > Possibility of automatic ordering of the keys by different criteria: code, name, best sellers, etc.
- > Configurable keyboard by PLUs, sections, vendors, QWERTY or ABC keyboard, etc.
- > Quick access to register articles, sellers and sections.
- > Quick change of the document to be generated: delivery note, receipt or simplified invoice.
- > Optional display of the receipt or label on the screen.
- > Easy cancellation of receipt lines / easy reopening of receipt.
- > Easy cancellation of lines in receipts.
- > Printing of receipts and labels with Windows fonts.
- > Receipts and labels design.
- > Invoices and delivery notes design.
- > Pre-defined formats of labels, delivery notes and simplified invoices.

- > Document format associated with client.
- > Personalization of header and logos in simplified invoices.
- > Issue of invoices and delivery notes.
- > Billing of delivery notes.
- > Cash desk closing.
- > Generation of lists and graphs for total sales or broken down (by article, client, vendor, period, etc.) with three output options: on screen, via scale printer or via an external printer.
- > Stocks, clients and providers management in the scale.
- > Deletion of negative stocks.
- > Traceability management.
- > Option to record normal price and offer price for each article.
- > Price lists associated to each store or client.
- > Management of stock and article orders.
- > Data migration.
- > Backup.
- > The application runs automatically at start up.
- > Automatic opto adjustment.
- > Functions for point of sale secure cash payment system (under license).
- > Functions for electronic labels and plastic card labellers (under license).
- > Turnomatic in buyer display function (under license).
- > For integrated turn management system with digital signage solutions, consult (on request).
- Also available with an open solution for the installation of any of the most popular POS terminal applications on the market.

Capacity / Accuracy

- Multi-range (3,000 divisions): 6 kg / 2 g - 15 kg / 5 g.
- Optional:
 - > Mono-range (3,000 divisions): 15 kg / 5 g or 30 kg / 10 g.
 - > Multi-range (3,000 divisions): 15 kg / 5 g - 30 kg / 10 g.
 - > Mono-range (6,000 divisions): 12 kg / 2 g or 30 kg / 5 g.

Formats

- Flat.
- Double body.
- Hanging.
- Self-service.

Construction

- Highly resistant ABS plastic casing in counter formats.
- Stainless steel casing in hanging format.
- Steel casing in flat format..
- Stainless steel plate.
- Access to all non-metrological components without the need to unseal the scale.

Displays

- Vendor: fully configurable 15" projected capacitive or resistive touch screen TFT in double body, hanging and self-service format (W250 x H188 mm); 10.4" projected capacitive (W215 x H161 mm) or 12.1" resistive projected capacitive TFT (W304 x H228 mm) in flat format.
- Buyer: 7" (W191 x H122 mm) or 15" (W304 x H228 mm). Allows showing advertising or promotional images even during the selling operation (more than 250 images and videos in the scale).

Printer(s)

- Models available with 1 printer for receipts, 1 printer for labels, 1 printer for labels or receipts (changing the paper roll and the working mode) or with 2 printers (for receipts and labels).
- 2" thermal printer in flat, double body, hanging and self-service format.
- 3" thermal printer for receipts with autocutter in double body format.
- 3" thermal printer for labels flat format (not suitable for receipts).
- Resolution: 8 dots/mm; speed: 100 mm/sec.
- Cassette for immediate paper roll change in 2" label printers (not available in 3" printers).
- Linerless with autocutter in label printer, depending on format.
- Optional:
 - > Extra external printer for invoices, lists, etc.

Receipts

- Paper width from W30 mm to W60 mm in 2", up to W80 in 3".
- Unlimited items.
- Unlimited programmable formats.
- Unlimited logos.
- Windows fonts.
- Barcodes: EAN-13, EAN-128, Code 128, IFT-14 and QR.
- Name of vendor.
- VAT break down.
- Unlimited payment modes.
- Discounts per line and total.
- Offers: 3x2, 2nd unit discount, price per segment, free product, etc.
- Loyalty points.
- Customers on account.
- Stamps.
- Unlimited receipts.





Labels

- Paper width from W30 mm to W60 mm in 2", up to W80 in 3".
- Unlimited programmable formats.
- Unlimited logos.
- Windows fonts.
- Barcodes: EAN-13, EAN-128, Code 128, IFT-14 and QR.
- Unlimited information fields.
- Unlimited programmable texts.
- Unlimited headings per label.
- Manual and automatic pre-packing modes.
- 3 levels of totals.
- Printing of "n" identical labels.
- Printing with 90°, 180° and 270° rotation.
- Packaging date, expiry date, freezing date and extra date (for any application).
- Alphanumeric batch number.
- Unlimited types of generic traceability (for meat, fish, fruits, vegetables, etc.) and unlimited products. Included in the prevailing European legislation on bovine traceability.

Food information

- Compliance with EU Regulation 1169/2011 on the obligation to provide nutrition information to consumers as of 13 December 2016:
 - > Minimum letter size: 1.2 mm.
 - > Windows fonts.
 - > Effects: **bold**, underlined, or any effect of a Windows font for each character in the text.
 - > Possibility of using the general text "G" (21 x 64,000) for ingMainsients to highlight allergens with those effects and fonts.
 - > Programmable allergen table: automatically identifies allergens in the ingMainsient texts.
 - > For receipts, possibility of indicating in the PLU "name 2" of those that contain allergens "Consult allergens" (or PLU* + "*Contains allergens").
 - > Possibility of printing 2 labels for each operation: programmable by PLU, configurable information, 2nd automatic or manual label (to be used also as promotional labels).

CPU

- Processor: Intel Celeron Brasswell.
- Memory: 4 GB.
- Hard disk: 128 GB SSD.
 - > Optional: RAM upgrade to 8 GB (can be modified without notice).

Communications

- 2 USB (3.0).
- 1 RS-232 (self powered for connection to barcode scanners).
- 2 Ethernet.
- 1 Display Port (additional screen).
- 1 audio (microphone).
- 1 line-out (speakers).
- Optional:
 - > Wi-Fi.

Security

- Programmable access levels through user profiles.

Connectivity with other devices

- PC.
- Receipt of sales data from Dibal CS-2100 Series, 500 Range and D-900 Series scales, and CL-3 Series PC labellers.
- Windows printers.
- Barcode scanner (built-in scanner optional).
- Manual and automatic cash drawer.
- Queueing system (for hanging and double body formats).
- Other peripherals: keyboard, mouse, etc.
- Point of sale secure cash payment system.
- Connectable to a single load cell weighing platform, up to 400 x 400 mm max., and up to 30 kg. Consult compatible scales formats.

Software

- SW CS SERIES for Windows: touch application for sales, weighing management and labels and receipts design (DLD).
- Integration tools: in Windows or Linux to facilitate communication with the Back-Office.

Power supply

- Mains: 110 up to 230 VAC.

Energy consumption

- 29.6-90 W (depending on the conditions of use).

1 RECEIPT PRINTER 3" AUTOCUTTER

Double Body Format



Dimensions

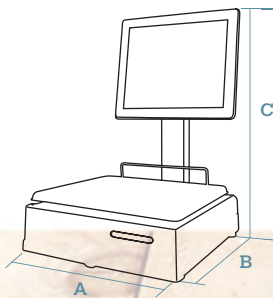

DATA IN mm

A	380
B	385
C	600

Plate dimensions:

L360 x W280 mm

Weight with packaging: 18.6 kg.

	Vendor display	Buyer display	Printer	Operating system	Sales software	Power	Capacity/Accuracy	Reference
CS-2250 W DB 15+7	15" resistive TFT touch screen	TFT 7"	3" Receipts (with autocutter)	Windows 10 (embedded)	CS SERIES SW compatible with open solution	Mains	6 kg / 2 g -15 kg / 5 g	7IATBDGLGE_ _
CS-2250 W DB 15+7	15" projected capacitive TFT touch screen	TFT 7"	3" Receipts (with autocutter)	Windows 10 (embedded)	CS SERIES SW compatible with open solution	Mains	6 kg / 2 g -15 kg / 5 g	7IATFDGLGE_ _
CS-2250 W DB 15+15	15" resistive TFT touch screen	TFT 15"	3" Receipts (with autocutter)	Windows 10 (embedded)	CS SERIES SW compatible with open solution	Mains	6 kg / 2 g -15 kg / 5 g	7IATCDGLGE_ _
CS-2250 W DB 15+15	15" projected capacitive TFT touch screen	TFT 15"	3" Receipts (with autocutter)	Windows 10 (embedded)	CS SERIES SW compatible with open solution	Mains	6 kg / 2 g -15 kg / 5 g	7IATGDGLGE_ _

M optional

1 LABEL PRINTER (OR RECEIPT) 2"

Flat
Format



Dimensions

DATA IN mm

A	382
B	520
C	180

Plate dimensions: L360 x W260 mm.
Weight with packaging: 12.5 kg.

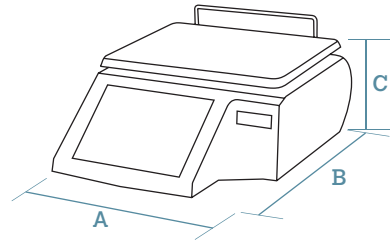

Cassette included.



	Vendor display	Buyer display	Printer	Operating system	Sales software	Power	Capacity/Accuracy	Reference
CS-2255 W F 10+7	10" projected capacitive TFT touch screen	TFT 7"	2" Labels (or Receipts)	Windows 10 (embedded)	CS SERIES SW compatible with open solution	Mains	6 kg / 2 g -15 kg / 5 g	7IA5SPGLGE_ _

(M) optional

1 LABEL PRINTER (OR RECEIPT) 2"

Double Body Format



Dimensions

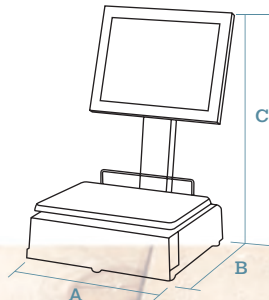

Cassette included.

DATA IN mm

A	380
B	385
C	600

Plate dimensions:
L360 x W280 mm.
Weight with packaging: 18.6 kg.

	Vendor display	Buyer display	Printer	Operating system	Sales software	Power	Capacity/Accuracy	Reference
CS-2255 W DB 15+7	15" resistive TFT touch screen	TFT 7"	2" Labels (or Receipts)	Windows 10 (embedded)	CS SERIES SW compatible with open solution	Mains	6 kg / 2 g - 15 kg / 5 g	7IA5BDGLGE_ _
CS-2255 W DB 15+7	15" projected capacitive TFT touch screen	TFT 7"	2" Labels (or Receipts)	Windows 10 (embedded)	CS SERIES SW compatible with open solution	Mains	6 kg / 2 g - 15 kg / 5 g	7IA5FDGLGE_ _
CS-2255 W DB 15+15	15" resistive TFT touch screen	TFT 15"	2" Labels (or Receipts)	Windows 10 (embedded)	CS SERIES SW compatible with open solution	Mains	6 kg / 2 g - 15 kg / 5 g	7IA5CDGLGE_ _
CS-2255 W DB 15+15	15" projected capacitive TFT touch screen	TFT 15"	2" Labels (or Receipts)	Windows 10 (embedded)	CS SERIES SW compatible with open solution	Mains	6 kg / 2 g - 15 kg / 5 g	7IA5GDGLGE_ _

M optional

1 LABEL PRINTER (OR RECEIPT) 2" LINERLESS WITH AUTOCUTTER

Double Body Format



Dimensions

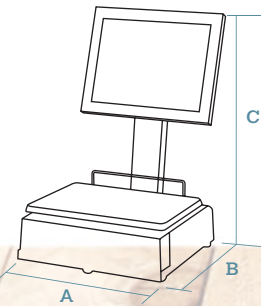

Cassette included.

DATA IN mm

- A** 380
- B** 385
- C** 600

Plate dimensions:
L360 x W280 mm.
Weight with packaging: 18.6 kg.



	Vendor display	Buyer display	Printer	Operating system	Sales software	Power	Capacity/ Accuracy	Reference
CS-2255 W DB 15+7	15" resistive TFT touch screen	TFT 7"	2" Labels (or Receipts) linerless with autocutter	Windows 10 (embedded)	CS SERIES SW compatible with open solution	Mains	6 kg / 2 g -15 kg / 5 g	7IANBDGLGE__
CS-2255 W DB 15+7	15" projected capacitive TFT touch screen	TFT 7"	2" Labels (or Receipts) linerless with autocutter	Windows 10 (embedded)	CS SERIES SW compatible with open solution	Mains	6 kg / 2 g -15 kg / 5 g	7IANFDGLGE__
CS-2255 W DB 15+15	15" resistive TFT touch screen	TFT 15"	2" Labels (or Receipts) linerless with autocutter	Windows 10 (embedded)	CS SERIES SW compatible with open solution	Mains	6 kg / 2 g -15 kg / 5 g	7IANCDGLGE__
CS-2255 W DB 15+15	15" projected capacitive TFT touch screen	TFT 15"	2" Labels (or Receipts) linerless with autocutter	Windows 10 (embedded)	CS SERIES SW compatible with open solution	Mains	6 kg / 2 g -15 kg / 5 g	7IANGDGLGE__

1 LABEL PRINTER (OR RECEIPT) 2"

S. Steel Hanging Format



Dimensions

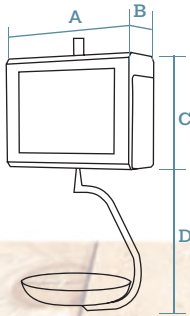

Cassette included.

DATA IN mm

A	408
B	170
C	315
D	415

Plate dimensions: Ø 310 mm.
Weight with packaging: 19.1 kg.

	Vendor display	Buyer display	Printer	Operating system	Sales software	Power	Capacity/Accuracy	Reference
CS-2255 W H 15+7	15" resistive TFT touch screen	TFT 7"	2" Labels (or Receipts)	Windows 10 (embedded)	CS SERIES SW compatible with open solution	Mains	6 kg / 2 g - 15 kg / 5 g	7IA5BCGSIE__
CS-2255 W H 15+7	15" projected capacitive TFT touch screen	TFT 7"	2" Labels (or Receipts)	Windows 10 (embedded)	CS SERIES SW compatible with open solution	Mains	6 kg / 2 g - 15 kg / 5 g	7IA5FCGSIE__
CS-2255 W H 15+15	15" resistive TFT touch screen	TFT 15"	2" Labels (or Receipts)	Windows 10 (embedded)	CS SERIES SW compatible with open solution	Mains	6 kg / 2 g - 15 kg / 5 g	7IA5CCGSIE__
CS-2255 W H 15+15	15" projected capacitive TFT touch screen	TFT 15"	2" Labels (or Receipts)	Windows 10 (embedded)	CS SERIES SW compatible with open solution	Mains	6 kg / 2 g - 15 kg / 5 g	7IA5GCGSIE__

M optional

1 LABEL PRINTER 3"

Flat
Format



Dimensions

DATA IN mm

A	440
B	550
C	185

Plate dimensions: L360 x W280 mm.
Weight with packaging: 16.6 kg.

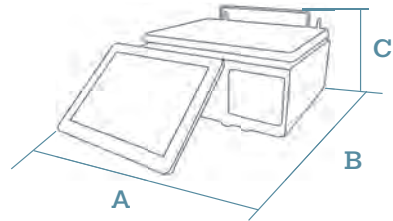

	Vendor display	Buyer display	Printer	Operating system	Sales software	Power	Capacity/Accuracy	Reference
CS-2255 W F 12+7	12" resistive TFT touch screen	TFT 7"	3" Labels	Windows 10 (embedded)	CS SERIES SW compatible with open solution	Mains	6 kg / 2 g -15 kg / 5 g	7IAELPGLNE__

M optional

2 PRINTERS (RECEIPTS AND LABELS) 2"

Double Body Format



Dimensions

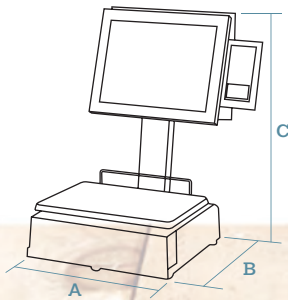

Cassette included.

DATA IN mm

A	380
B	385
C	600

Plate dimensions:
L360 x W280 mm.
Weight with packaging: 22.0 kg.



	Vendor display	Buyer display	Printer	Operating system	Sales software	Power	Capacity/Accuracy	Reference
CS-2257 W DB 15+7	15" resistive TFT touch screen	TFT 7"	2" Receipts + 2" Labels	Windows 10 (embedded)	CS SERIES SW compatible with open solution	Mains	6 kg / 2 g - 15 kg / 5 g	7IA7BDGLGE_ _
CS-2257 W DB 15+7	15" projected capacitive TFT touch screen	TFT 7"	2" Receipts + 2" Labels	Windows 10 (embedded)	CS SERIES SW compatible with open solution	Mains	6 kg / 2 g - 15 kg / 5 g	7IA7FDGLGE_ _
CS-2257 W DB 15+15	15" resistive TFT touch screen	TFT 15"	2" Receipts + 2" Labels	Windows 10 (embedded)	CS SERIES SW compatible with open solution	Mains	6 kg / 2 g - 15 kg / 5 g	7IA7CDGLGE_ _
CS-2257 W DB 15+15	15" projected capacitive TFT touch screen	TFT 15"	2" Receipts + 2" Labels	Windows 10 (embedded)	CS SERIES SW compatible with open solution	Mains	6 kg / 2 g - 15 kg / 5 g	7IA7GDGLGE_ _

M optional

Accessories: Labellers for tags on plastic cards

Packs to print price tags on plastic cards:

Edikio Flex pack:

- Single-sided printing.
- Standard or long cards.

Edikio Duplex pack:

- Double-sided printing. -
- Standard cards.



Pack Edikio Flex

The packs include:

	Printer	Software	No. of PVC cards	No. of transfer ribbons	Reference
Pack Edikio Flex	Edikio Flex (for single-sided printing)	Edikio Standard	100 (mat black)	1 (white)	BI0586
Pack Edikio Duplex	Edikio Duplex (for double-sided printing)	Edikio Pro	200 (mat black)	1 (white)	BI0587

They also include: 1 usb cable, 1 start cleaning kit with block and power cable.

Note: 2-year warranty for the Edikio Flex pack printer and 3-year warranty for the Edikio Duplex pack printer.

Accessories: wireless electronic labels

Electronic labels

ses imagotag



Ref: BI0552

2.7" label

- Dimension of the label: 85.7 x 50 x 16.6 mm.
- Dimension of the display: 57.3 x 38.2 mm.
- Minimum order of 80 units.



Ref: BI0553

4.2" label

- Dimension of the label: 114.9 x 88.9 x 17.4 mm.
- Dimension of the display: 84.8 x 63.6 mm.
- Minimum order of 60 units.



Ref: BI0554

4.2" label with IP67 protection

- Ideal for fishmongers.
- Dimension of the label: 114.9 x 88.9 x 17.4 mm.
- Dimension of the display: 84.8 x 63.6 mm.
- Minimum order of 60 units.

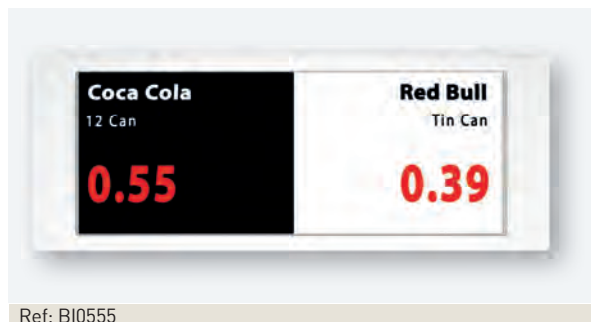

Ref: BI0555

4.5" label

- Dimension of the label: 132.6 x 50.9 x 16.4 mm.
- Dimension of the display: 104.2 x 38.2 mm.
- Minimum order of 60 units.



Ref: BI0556

7.4" label

- Dimension of the label: 186.9 x 125.9 x 19.3 mm.
- Dimension of the display: 161.6 x 97 mm.
- Minimum order of 10 units.

4PBPI series

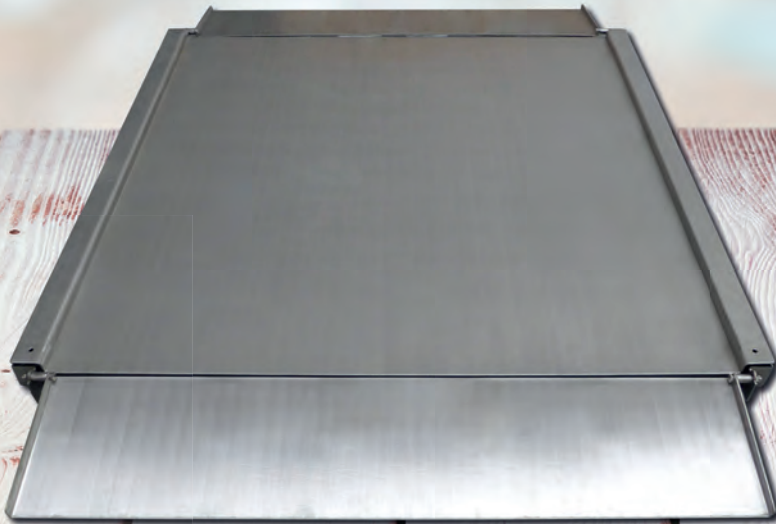

Dimensions

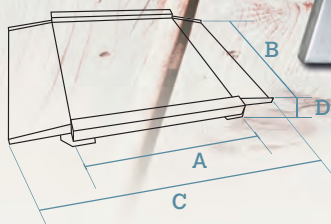

DATA IN mm

A	B	C	D (min.)	D (max.)
800	800	1,800	50	60
1,000	1,000	2,000	50	60
1,200	1,200	2,200	50	60
1,200	1,500	2,500	50	60
1,500	1,500	2,500	50	60

Platform Size	Packaging measures:	Weight with packaging:
800 x 800 mm	L820 x W820 x H120 mm	85.0 kg
1,000 x 1,000 mm	L1,020 x W1,020 x H120 mm	111.0 kg
1,200 x 1,200 mm	L1,220 x W1,220 x H120 mm	145.0 kg
1,200 x 1,500 mm	L1,220 x W1,520 x H120 mm	150.0 kg
1,500 x 1,500 mm	L1,520 x W1,520 x H120 mm	180.0 kg

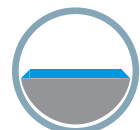

LOW PROFILE



4 LOAD
CELLS



METROLOGICAL
VERIFICATION
OPTIONAL (EU)

Characteristics

Main characteristics

- Top-of-floor low profile weighing platform.
- 4 load cells.
- Valid for legal metrology (see section on equipment metrological verification).

Construction

- Structure: AISI 304 stainless steel.
- Plate: 5 mm thick stainless steel sheet.
- 4 stainless steel load cells (IP67).
- AISI 304 stainless steel junction box.

- 5 m cable to connect the load cells to a weight indicator.
- 2 access ramps included.
- Height adjustable feet.

Possible integration with other equipment

- Dibal weight indicators.
- Cely weight indicators.
- Dibal LP-545 manual weigh-price labeller.
- Cely PC-60 piece counting scale.

Models

CAPACITY 600 kg (3,000 divisions)

800 x 800 mm

Ref.:
71HV8S0105 _ _ _

CAPACITY 1,500 kg (3,000 divisions)

1,000 x 1,000 mm

Ref.:
71HV8S0207 _ _ _

1,200 x 1,200 mm

Ref.:
71HV8S1207 _ _ _

1,200 x 1,500 mm

Ref.:
71HV8S1307 _ _ _

1,500 x 1,500 mm

Ref.:
71HV8S0607 _ _ _

(M) optional

Options

Option	Characteristics	Ref.
Metrological verification (M)	According to EU weighing directives. [See section on equipment metrological verification].	Consult

Accessories



> Stainless steel column for indicator

Accessory	Platform model	Ref.
Stainless steel H1,000 mm column for indicator	800 x 800 / 1,000 x 1,000 / 1,200 x 1,200 / 1,200 x 1,500 / 1,500 x 1,500 mm.	BB-C2610

PPI series

Dimensions

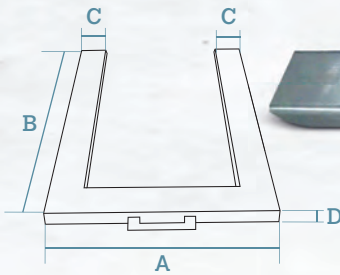

DATA IN mm

A	B	C	D (min.)	D (max.)
840	1,250	120	83	93

Packaging measures:
L1,360 x W950 x H140 mm

Weight with packaging:
48.0 kg



MOBILE



4 LOAD CELLS



METROLOGICAL VERIFICATION
OPTIONAL (EU)

Characteristics

Main characteristics

- Pallet weighing scale.
- Floor installation.
- "U" shaped structure to enable entry with manual forklift.
- 4 load cells.
- Valid for legal metrology (see section on equipment metrological verification).

Construction

- Structure: AISI 304 stainless steel.
- 4 stainless steel load cells (IP67).
- AISI 304 stainless steel junction box.
- 5 m cable to connect the load cells to a weight indicator.
- With grip and 2 wheels.
- Height adjustable feet.

Possible integration with other equipment

- Dibal weight indicators.
- Cely weight indicators.
- Dibal LP-500 manual weigh-price labeller.
- Cely PC-60 piece counting scale.

Models

CAPACITY 1,500 kg (3,000 divisions)

1,250 x 840 mm

Ref.: **71HUSS0507** _ _ _

(M) optional

Accessories



Stainless steel
column for indicator

Dimensions: H1,000 mm.

Ref: BB-C2610

Options

Option	Characteristics	Ref.
Metrological verification (M)	According to EU weighing directives. (See section on equipment metrological verification).	Consult

MI series

Dimensions

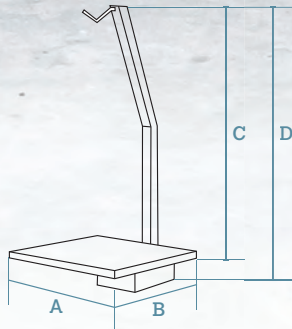

DATA IN mm

A	550
B	550
C	1,080
D	1,300

Weight with packaging: 41.0 kg.

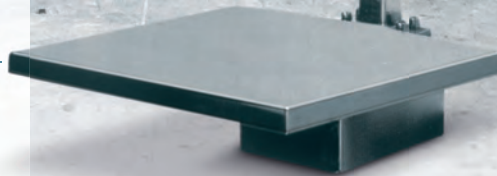

WALL



FOLDING



1 LOAD
CELL



METROLOGICAL
VERIFICATION
OPTIONAL (EU)

Characteristics

Main characteristics

- On wall weighing scale.
- Weighing on the hook or folding plate.
- 1 load cell.
- Valid for legal metrology (see section on equipment metrological verification).

Construction

- AISI 304 stainless steel structure.
- Stainless steel load cell (IP68).
- Plate: Stainless steel.

Possible integration with other equipment

- Dibal weight indicators.
- Cely weight indicators.
- Dibal LP-500 manual weigh-price labeller.
- Cely PC-60 piece counting scale.

Models

CAPACITY 150 kg (3,000 divisions)

550 x 550 mm

Ref.: **71IMU10903**_ _ _

CAPACITY 300 kg (3,000 divisions)

550 x 550 mm

Ref.: **71IMU10904**_ _ _

(M) optional

Options

Option	Characteristics	Ref.
Metrological verification (M)	According to EU weighing directives. (See section on equipment metrological verification).	Consult

AG1 series

Dimensions

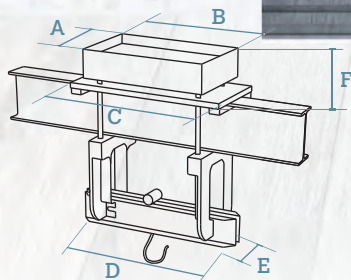

DATA IN mm

A	B	C	D
210	360	450	300
E	F (min.)	F (max.)	
140	105	115	

Weight with packaging: 28.0 kg.



AERIAL



1 LOAD CELL



METROLOGICAL VERIFICATION
OPTIONAL (EU)

Characteristics

Main characteristics

- Weighing scale for overhead track lines.
- 1 load cell.
- Valid for legal metrology (see section on equipment metrological verification).

Construction

- 2 versions:
 - > A- Painted iron structure with steel load cell (IP68).
 - > B- Stainless steel structure with stainless steel load cell (IP68).

Possible integration with other equipment

- Dibal weight indicators.
- Cely weight indicators.
- Dibal LP-500 manual weigh-price labeller.
- Cely PC-60 piece counting scale.

Models

A VERSION:

PAINTED IRON STRUCTURE

B VERSION:

STAINLESS STEEL STRUCTURE

CAPACITY 150 kg (3,000 divisions)

Ref.: **711A1P0003** _ _ _

Ref.: **711A1I0003** _ _ _

CAPACITY 300 kg (3,000 divisions)

Ref.: **711A1P0004** _ _ _

Ref.: **711A1I0004** _ _ _

CAPACITY 600 kg (3,000 divisions)

Ref.: **711A1P0005** _ _ _

Ref.: **711A1I0005** _ _ _

(M) optional

Options

Option	Characteristics	Ref.
Metrological verification (M)	According to EU weighing directives. (See section on equipment metrological verification).	Consult

serie AI2



Dimensions

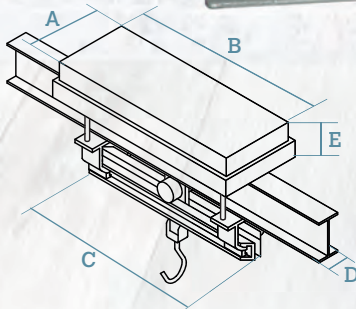

DATA IN mm

A	B	C (min.)	C (max.)	D (max.)	E
240	600	560	600	120	110

Weight with packaging: 18.0 - 30.0 kg.



AERIAL



2 LOAD
CELLS



METROLOGICAL
VERIFICATION
OPTIONAL (EU)

Characteristics

Main characteristics

- Weighing scales for overhead track lines.
- 2 load cells.
- Valid for legal metrology (see section on equipment metrological verification).

Construction

- 2 versions:
 - > A- Stainless steel coated galvanised steel structure with aluminium load cells (IP67).
 - > B- Stainless steel coated galvanised steel structure with stainless steel load cells (IP67).

Possible integration with other equipment

- Dibal weight indicators.
- Cely weight indicators.
- Dibal LP-500 manual weigh-price labeller.
- Cely PC-60 piece counting scale.

Models

A VERSION:
ALUMINIUM LOAD CELLS

B VERSION:
STAINLESS STEEL LOAD CELLS

CAPACITY 300 kg (3,000 divisions)

Ref.: **711A2H0004** _ _ _

Ref.: **711A2I0004** _ _ _

CAPACITY 600 kg (3,000 divisions)

Ref.: **711A2H0005** _ _ _

Ref.: **711A2I0005** _ _ _

(M) optional

Options

Option	Characteristics	Ref.
Metrological verification (M)	According to EU weighing directives. [See section on equipment metrological verification].	Consult

WEIGHT
INDICATOR

DMI-610 model

Dimensions

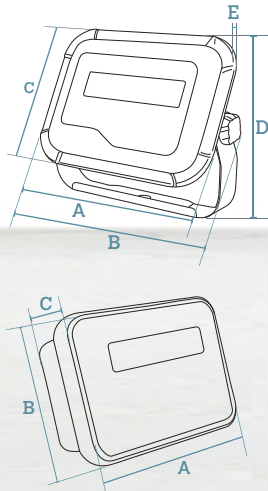

DATA IN mm

	DMI-610 Basic ABS and DMI-610 ABS	DMI-610 S. Steel
A	249	260
B	174	273
C	108	188
D		210.5
E		74

Weight with packaging: 2.1 kg.



LED
SEGMENT
DISPLAY



CONNECTABLE TO
PLATFORM UP TO
14 LOAD CELLS



RS-232

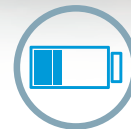

INTERNAL
RECHARGEABLE
BATTERY
OPTIONAL



METROLOGICAL
VERIFICATION
OPTIONAL (EU)

Characteristics and functionality

Outstanding functions

- Weight-Tare-Accumulation.
- Piece counting.
- Checkweighing (minimum-target-maximum).
- Dosing: 1 product / 2 speeds (with 4 Input/Output option. Only available for DMI-610 stainless steel).
- Checkweighing (with 4 Input/Output option. Only available for DMI-610 stainless steel).
- 4-20 mA / 0-10 V analog output (optional and only available for DMI-610 stainless steel).
- Real time clock, battery-run.
- Optional internal storage memory.
- Repeater.

CPU

- Processor / Microprocessor: ARM 32 bit cortex M3.
- Memory: 256 Kb Flash and 48 Kb RAM.

Weighing

- Connection to 1 weighing platform of up to 14 load cells.
- Alignment: up to five adjustment points.
- Up to 6,000 divisions. Mono-range, multi-range or multi-interval.

Construction

- Structure:
 - > High-resistance ABS plastic in models DMI-610 Basic ABS and DMI-610 ABS.
 - > AISI 304 stainless steel in model DMI-610 stainless steel.
- Keypad and display:
 - > Keypad with 7-keys and LED display with 6 red digits (1" - 25.4 mm).
- Working mode lighting indicators: weight (kg, lb), piece counting, checkweighing...
- Adjustable angle mount for table or wall included.

Communication to PC

- Two RS-232 ports, one of them selfpowered (5 V / 500 mA).
- Ethernet (TCP/IP and UDP) (optional).
- RS-485/RS-422 optional (only available for DMI-610 stainless steel).
- Several communications protocols available (contact us).

PC Software

- DCM:
 - > Configuration of the indicator and backup.
 - > Management and processing of data gathered by the indicator.

Power supply

- 230 V / 50 Hz; 115 V / 60 Hz in DMI-610 ABS and DMI-610 stainless steel models.
- 12 VDC adaptor in DMI-610 Basic ABS model.
- Internal rechargeable battery (Li-ion), optional in DMI-610 ABS and DMI-610 stainless steel models.
 - > Up to 44 hours' runtime (depending on conditions of use).

Possible integration with other equipment

- Dibal LP-500 manual weigh-price labeller.
- Cely RD-5 repeater (or other DMI as repeater).

Other possible connections

- External printer.
- Other devices, with 4 Input/Output option and only available in DMI-610 stainless steel model.

Energy consumption

- 20 W (approx.).

Models

DMI-610 BASIC ABS

- Connectable to 1 weighing platform of up to 14 load cells.
- It does not offer any options.

Ref.: **7VA1A0N1UE + 49-6000**

DMI-610 ABS

- Connectable to 1 weighing platform of up to 14 load cells.
- Internal rechargeable battery, optional.
- It does not offer all the options.

Ref.: **7VA3A0N1UE + 49-6000**

DMI-610 S. STEEL

- Connectable to 1 weighing platform of up to 14 load cells.
- Internal rechargeable battery, optional.
- It offers all the options.

Ref.: **7VA3A0I1UE**

(M) optional

Options

Option	Characteristics	Ref.
Internal rechargeable battery (Li-ion) *		Consult
Ethernet communication *	TCP/IP and UDP.	Consult
4 Input/Output *	Dosing with queue control included. (Only available in DMI-610 stainless steel).	Consult
Analog output *	4-20 mA / 0-10 V. (Only available in DMI-610 stainless steel).	Consult
RS-485/RS-422 communications	(Only available in DMI-610 stainless steel).	Consult
Internal storage memory		Consult
Connection to external power supply 12/24 V		Consult
DCM software	Configuration of the indicators and backup. Management and processing of data gathered by the indicators. (See section on software).	7340I0U3
Metrological verification (M)	According to EU weighing directives for indicator + platform assemblies. (See section on equipment metrological verification).	Consult

* The options: Internal rechargeable battery, Ethernet communication, 4 Input/Output and Analog output, cannot be simultaneous.
 Note: The DMI-610 Basic ABS indicator does not allow options.

Accessories

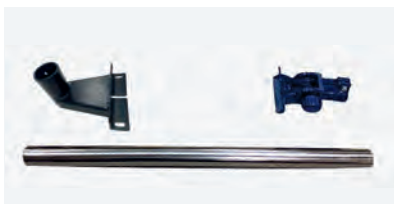

Iron column kit for DMI-610 BASIC ABS or DMI-610 ABS indicators

H330 mm column

Ref: 495700A

H660 mm column

Ref: 495701A



Stainless steel column kit for DMI-610 stainless steel indicator

H330 mm column

Ref: 495702A

H660 mm column

Ref: 495703A

DMI-620 model

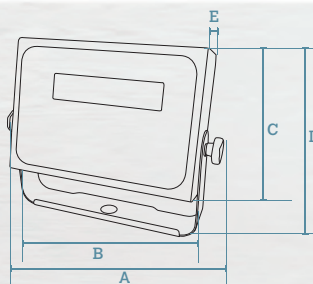

Dimensions DATA IN mm

A	294
B	253
C	178
D	238
E	74.5

Weight with packaging: 3.0 kg.

LED
SEGMENT
DISPLAYCONNECTABLE TO
PLATFORM UP TO
14 LOAD CELLSCONNECTION TO
2nd PLATFORM
OPTIONALUP TO
400 PLUsUSB
OPTIONAL

RS-232

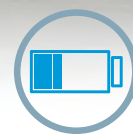
INTERNAL
RECHARGEABLE
BATTERY
OPTIONALMETROLOGICAL
VERIFICATION
OPTIONAL (EU)

Characteristics and functionality

Outstanding functions

- Weight-Tare-Accumulation.
- Piece counting.
- Checkweighing (minimum-target-maximum).
- Programmable tares (up to 10).
- Weights saving (up to 1,000).
- Dosing: 1 product / 2 speeds (with 4 Input/Output option).
- Checkweighing (with 4 Input/Output option). 1 or 2 optional plates.
- 4-20 mA / 0-10 V analog output (optional).
- Real time clock, battery-run.
- Database for 400 PLUs (products) and 400 records (clients, suppliers, operators...).
- Optional internal storage memory.
- Repeater.

CPU

- Processor/Microprocessor: ARM 32 bit cortex M3.
- Memory: 256 Kb Flash and 48 Kb RAM.

Weighing

- Connection to 1 weighing platform of up to 14 load cells. (Connection to 2nd platform –up to 14 load cells–, optional).
- Alignment: up to five adjustment points.
- Up to 6,000 divisions. Mono-range, multi-range or multi-interval.

Construction

- Structure:
 - > AISI 304 stainless steel.
- Keypad and display:
 - > Keypad with 19-keys and LED display with 6 red digits (1" - 25.4 mm).
- Working mode lighting indicators: weight (kg, lb), piece

counting, checkweighing...

- Adjustable angle mount for table or wall included.

Communication to PC

- 2 RS-232 ports, one of them selfpowered (5 V / 500 mA).
- RS-485/RS-422 (optional).
- Ethernet (TCP/IP and UDP) (optional).
- USB port (optional).
- Wi-Fi (optional).
- Several communications protocols available (consult).

PC Software

- DCM:
 - > Configuration of the indicator and backup.
 - > Management and processing of data gathered by the indicator.

Power supply

- 110-230 VAC direct.
- Internal rechargeable battery (Li-ion) optional.
 - > Up to 44 hours' runtime (depending on conditions of use).

Possible integration with other equipment

- Dibal LP-500 manual weigh-price labeller.
- Cely RD-5 repeater (or other DMI as repeater).

Other possible connections

- External printer (Epson protocol), for printing reports.
- Other devices, with the 4 Input/ Output option.

Energy consumption

- 20 W (approx.).

Models

DMI-620

Ref.: **7VC3A0I1UE**

(M) optional

Options

Option	Characteristics	Ref.
Internal rechargeable battery (Li-ion)		Consult
Ethernet communication**	TCP/IP and UDP.	Consult
4 Input/Output **	It includes dosing with queue control.	Consult
Analog output**	4-20 mA / 0-10 V.	Consult
RS-485/RS-422 communications		Consult
Internal storage memory		Consult
Additional 4 Input/Output plate**		Consult
USB **		Consult
Ethernet + USB **		Consult
Wi-Fi	Wireless communications.	Consult
Connection to 2 nd weighing platform	<i>(It does not offer type approval).</i>	Consult
DCM software	Configuration of the indicators and backup. Management and processing of data gathered by the indicators. (See section on software).	7340I0U3
Metrological verification (M)	According to EU weighing directives for indicator + platform assemblies. (See section on equipment metrological verification).	Consult

* The internal rechargeable battery option cannot be simultaneous with the following options: Ethernet communication, 4 Input/Output, Analog output, USB and Ethernet + USB.

**Options: Ethernet communication, 4 Input/Output, Analog output, USB and Ethernet + USB, can be simultaneous (to a maximum of 2 options).

Accessories



Stainless steel column kit

H330 mm column
Ref: 495702A

H660 mm column
Ref: 495703A



Ref: Consult

Barcode readers

Scanner. RS-232 connection.

BEV series



DIBAL
INDICATOR
DMI-600 SERIES



1 LOAD
CELL



METROLOGICAL
VERIFICATION
OPTIONAL (EU)

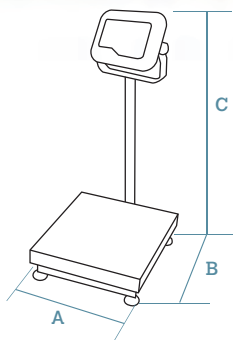

Dimensions DATA IN mm

A	B	C (min.)		C (max.)	
		DMI-610 Basic ABS and DMI-610 ABS	DMI-610 S. Steel	DMI-610 Basic ABS and DMI-610 ABS	DMI-610 S. Steel
300	300	540	580	555	595
400	400	840	880	855	895
600	600	840	880	855	895
800	800	840	880	855	895

Weight with packaging: 11.6 - 83.1 kg.

Characteristics and functionality

Main characteristics

- Set consisting of weight indicator, column and weighing platform.
- 1 load cell.
- Valid for legal metrology (see section on equipment metrological verification).

Functions

- Weight-Tare-Accumulation.
- Piece counting.
- Checkweighing (minimum-target-maximum).
- Dosing: 1 product / 2 speeds (with 4 Input/Output option. Only available for model DMI-610 stainless steel).
- Checkweighing (with 4 Input/Output option. Only available

for model DMI-610 stainless steel).

- 4-20 mA / 0-10 V analog output (optional, only available for DMI-610 stainless steel model).
- Optional internal storage memory.

Construction

- 3 platform versions available:
 - > A- Iron structure, aluminium load cell and stainless steel plate.
 - > B- Stainless steel structure, aluminium protected load cell and stainless steel plate (not suitable for saline environments).
 - > C- Stainless steel structure, load cell and plate.
- DMI-610 Inox.
- Height adjustable feet.

- 3 weight indicator versions available:
 - > DMI-610 Basic ABS.
 - > DMI-610 ABS.
 - > DMI-610 S. Steel.
 See section on weight indicators and repeaters.

Communications

- 2 RS-232 ports, 1 of them selfpowered (5 V / 500 mA).
- Ethernet (TCP/IP and UDP) (optional).
- RS-485/RS-422 optional (only available for the DMI-610 stainless steel).
- Several communications protocols available (consult).

Simultaneous options

- DMI-610 Basic ABS: no options allowed.
- DMI-610 ABS / S. Steel: 1 option. Internal rechargeable

battery, Ethernet communication, 4 Input/Output and Analog output options cannot be simultaneous.

Possible integration with other equipment

- External printer (Epson protocol).
- Dibal LP-500 and CL-3 manual weigh-price labellers (CL-3 with up to 400 x 400 mm max. and up to 30 kg platforms).
- Cely RD-5 repeater (or another DMI as repeater).

PC Software

- DCM: For configuration, backup, management and processing of data received by the weight indicators.

Models

A version platform

Iron Structure - Aluminium Load Cell - Stainless Steel Plate

DIMENSIONS (mm)	CAPACITY (kg) (3,000 div.)	DMI-610 BASIC ABS			DMI-610 ABS			DMI-610 S. STEEL		
		Ref.	Ref.	Ref.	Ref.	Ref.	Ref.	Ref.		
300 x 300	6	7BRA1A0N1W380_	7BRA3A0N1W380_	7BRA3A0I1W380_						
	15	7BRA1A0N1N380_	7BRA3A0N1N380_	7BRA3A0I1N380_						
	30	7BRA1A0N1Y380_	7BRA3A0N1Y380_	7BRA3A0I1Y380_						
	60	7BRA1A0N1C380_	7BRA3A0N1C380_	7BRA3A0I1C380_						
400 x 400	15	7BRA1A0N1N480_	7BRA3A0N1N480_	7BRA3A0I1N480_						
	30	7BRA1A0N1Y480_	7BRA3A0N1Y480_	7BRA3A0I1Y480_						
	60	7BRA1A0N1C480_	7BRA3A0N1C480_	7BRA3A0I1C480_						
	150	7BRA1A0N11480_	7BRA3A0N11480_	7BRA3A0I11480_						
600 x 600	60	7BRA1A0N1C680_	7BRA3A0N1C680_	7BRA3A0I1C680_						
	150	7BRA1A0N11680_	7BRA3A0N11680_	7BRA3A0I11680_						
	300	7BRA1A0N13680_	7BRA3A0N13680_	7BRA3A0I13680_						
800 x 800	150	7BRA1A0N11880_	7BRA3A0N11880_	7BRA3A0I11880_						
	300	7BRA1A0N13880_	7BRA3A0N13880_	7BRA3A0I13880_						
	600	7BRA1A0N16880_	7BRA3A0N16880_	7BRA3A0I16880_						

B version platform

Stainless Steel Structure - Aluminium Protected Load Cell - Stainless Steel Plate

DIMENSIONS (mm)	CAPACITY (kg) (3,000 div.)	DMI-610 BASIC ABS			DMI-610 ABS			DMI-610 S. STEEL		
		Ref.	Ref.	Ref.	Ref.	Ref.	Ref.	Ref.	Ref.	
300 x 300	6	7BCA1A0N1W380_	7BCA3A0N1W380_	7BCA3A0I1W380_						
	15	7BCA1A0N1N380_	7BCA3A0N1N380_	7BCA3A0I1N380_						
	30	7BCA1A0N1Y380_	7BCA3A0N1Y380_	7BCA3A0I1Y380_						
400 x 400	15	7BCA1A0N1N480_	7BCA3A0N1N480_	7BCA3A0I1N480_						
	30	7BCA1A0N1Y480_	7BCA3A0N1Y480_	7BCA3A0I1Y480_						
	60	7BCA1A0N1C480_	7BCA3A0N1C480_	7BCA3A0I1C480_						
	150	7BCA1A0N11480_	7BCA3A0N11480_	7BCA3A0I11480_						
600 x 600	60	7BCA1A0N1C680_	7BCA3A0N1C680_	7BCA3A0I1C680_						
	150	7BCA1A0N11680_	7BCA3A0N11680_	7BCA3A0I11680_						
	300	7BCA1A0N13680_	7BCA3A0N13680_	7BCA3A0I13680_						
800 x 800	150	7BCA1A0N11880_	7BCA3A0N11880_	7BCA3A0I11880_						
	300	7BCA1A0N13880_	7BCA3A0N13880_	7BCA3A0I13880_						

(M) optional

C version platform

Stainless Steel Structure - Stainless Steel Load Cell - Stainless Steel Plate

DIMENSIONS (mm)	CAPACITY (kg) (3,000 div.)	DMI-610 S. STEEL		
		Ref.	Ref.	Ref.
300 x 300	6	7BSA3A0I1W380_		
	15	7BSA3A0I1N380_		
	30	7BSA3A0I1Y380_		
	60	7BSA3A0I1C380_		
400 x 400	15	7BSA3A0I1N480_		
	30	7BSA3A0I1Y480_		
	60	7BSA3A0I1C480_		
	150	7BSA3A0I11480_		
600 x 600	60	7BSA3A0I1C680_		
	150	7BSA3A0I11680_		
	300	7BSA3A0I13680_		
800 x 800	150	7BSA3A0I11880_		
	300	7BSA3A0I13880_		
	600	7BSA3A0I16880_		

(M) optional

Options

Option	Characteristics	Ref.
Metrological verification (M)	According to EU weighing directives. (See section on equipment metrological verification).	Consult

MANUAL WEIGH-PRICE
LABELLER

LP-500 series



Dimensions

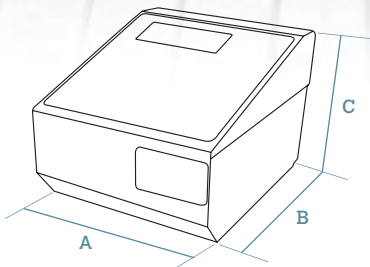

DATA IN mm

A	285
B	285
C	240

Weight with packaging: 9.0 kg.



1 PRINTER 2"
LABELS



LCD
GRAPHIC
DISPLAY



UP TO
10,000 PLUS



UP TO
20
OPERATORS



CONNECTABLE TO
PLATFORM UP TO
4 LOAD CELLS

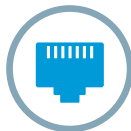

ETHERNET
TCP/IP



USB



WI-FI
OPTIONAL



METROLOGICAL
VERIFICATION
OPTIONAL (EU)

Model

	Display	Printer	PLUs	Direct PLUs	Operators	Power	Reference
LP-545	LCD Graphic	Labels (or Receipts)	10,000	80x2	20	Mains	7L453050IZ_ _

M optional

Characteristics and functionality

Main characteristics

- High performance label printer (suitable also for receipts).
- Compliance with EU Regulation 1169/2011 on the provision of food information to consumers.

Features

- Extensive information for each PLU: normal price and offer price, price for weight scales and by kg/100 g, 3 names of 20 characters or 2 names of 30 characters, 20 free texts of 24 characters, 1 text of 3,000 characters, etc.
- PLU search by number or name.
- Preset keys to programming menus: to change prices, register PLUs or vendors, etc.
- Direct access to 999 PLUs from the keyboard.
- Printing of the labeller menus.
- Programmable macros: recording of a sequence of keys to create direct access to any task (reopening of receipt, lists, change in batcher number, etc.). LP-500 labellers have as many macros as direct PLU keys, besides 10 specific macros keys.
- Sales and management reports: sales (by article, vendor, time frames, last month, etc.), modified PLUs, etc.
- Fast and reliable communication between labellers, with PC and mobile devices (via DWS).
- Option to record normal price and offer price for each article.
- Stock management by article.
- Piece counting function.

Weighing

- Connection to 1 or 4 load cells platform.

Construction

- Stainless steel casing.
- Access to all non-metrological components without the need to unseal the labeller.

Display

- LCD matrix graphic display.
- 2 selectable screens: full information (weight, price / kg, tare, operators and article's name) or weight only (with checkweighing function).

Keyboard

- 150 keys (15 x 7).
- 80 x 2 article preset keys (direct PLUs).

Printer

- Label printer (also suitable for receipts by changing the paper roll and the working mode).
- 54 mm thermal printer.
- Resolution: 8 dots/mm; speed: 100 mm/sec.
- Cassette for immediate paper roll change (included).
- Optional:
 - > Linerless.

Labels

- 15 fonts (6 monospaced + 9 multispaced: more modern and legible).
- From W30 x L30 mm to W60 x L150 mm.
- 20 fixed formats + 40 programmable formats.
- 100 logos.
- Barcodes: EAN-13, EAN-128 and Code 128.
- QR codes.
- 60 fields of information.
- 100 programmable texts.
- Manual and automatic pre-packing modes.
- 3 levels of totals.
- Printing of "n" identical labels.
- Printing with 90°, 180° and 270° rotation.
- Automatic adjustment of the paper detection sensor.
- Checkweigher function: it only prints the label if the product is between a pre-established minimum and maximum weight.
- Packaging date, expiry date and extra date (for any application).
- Alphanumeric batch number.
- 10 types of generic traceability (for meat, fish, fruits, vegetables, etc.) up to 99 products. Included in the prevailing European legislation on bovine traceability.

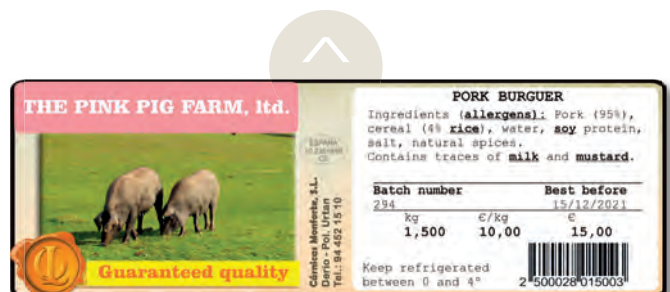

Receipts

- 15 fonts (6 monospaced + 9 multispaced: more modern and legible).
- Up to 75 items.
- 2 fixed formats + 2 programmable formats.
- 4 logos.
- Barcodes: EAN-13, EAN-128 and Code 128.
- Name of vendor.
- 9 payment methods.
- Total in National currency and other 3 currencies.
- Discounts per line and total.
- Loyalty points.
- Customers on account.
- Recipes.



Food information

- Compliance with EU Regulation 1169/2011 on the provision of food information to consumers as of 13 December 2016:
 - > Minimum letter size: 1.2 mm.
 - > Effect (**bold**, underlined, or **both**) for each character in the text.
 - > Possibility of using the general text "G" (3,000 characters) for ingredients, in lower case or UPPER CASE to highlight allergens.
 - > Possibility of including a table of nutritional facts.
 - > Free texts (20 x 24 characters).
 - > For direct sale receipts and labels: possibility of indicating in the PLU name (with an * or other symbol) those that contain allergens and programming a text, such as "* Consult allergens".
 - > Possibility of printing 2 labels for each operation: programmable by PLU, configurable information, 2nd automatic or manual label (also to be used as promotional labels).

Communications

- TCP/IP Ethernet for interconnection and connection to PC.
- RS-232, for connection to scanner.
- USB.
- Optional:
 - > Wi-Fi.

Security

- Access to different protected programming menus via configurable passwords.

Interconnection

- Up to 16 Dibal LP-500 labellers or 16 Dibal Star series scales.

Connectivity with other devices

- PC.
- Barcode scanner (powered by the labeller -5 VDC-) to read EAN-13 and EAN-128 barcodes.

Possible integration with other equipment

- 1 or 4 load cells weighing platforms.
- Dibal weight indicators.
- Other LP-500.
- Dibal Star series scales.

Software

(See section on software)

PC software:

- DFS:
 - > Programming of labellers.
 - > Receipt of sales data.
 - > Data backup copy.
 - > Graphic design of receipts and labels.
 - > Design and management of advertising images for graphic display.
- Integration tools: in Windows or Linux to facilitate communication with the Back Office.

Labeller firmware:

- DWS (Dibal Web Server):
 - > Allows access to the information on each labeller from any computer or mobile device with an Internet browser.

Power supply

- Mains: 110 up to 230 VAC.
- Optional:
 - > Anti-blackout 24 V rechargeable internal battery and connector to external battery 24 V.

Energy consumption

- 5.6-90 W (depending on the conditions of use).

Options

Option	Characteristics	Ref.
Linerless	Label or receipt on continuous adhesive paper without supporting paper.	Consult
Wi-Fi	Wireless communications (IEEE 802.11n).	Consult
Anti-blackout	Anti-blackout internal battery 24 V + external battery connector 24 V.	Consult
DFS Software	Labeller configuration, receipt of sales data for processing with other IT applications and data backup (LBS), and labels and receipts graphic design (DLD). (See section on software).	7340F1U1
		7340FNU1
		7340D1U1
		7340DNU1
Technical DWS Firmware	For the remote configuration of the labeller. (See section on software).	7340W101
Full DWS Firmware	For the remote configuration of the labeller and processing of the information generated. (See section on software).	7340WN01
Metrological verification (M)	According to EU weighing directives. (See section on equipment metrological verification).	Consult

Accessories



Ref: BC-668

Barcode wireless scanner

Includes connection cable between the wireless scanner base and the labeller.



Ref: BI0364

Barcode scanner

Includes connection cable to labeller.



Ref: BCES0007

Additional cassette

For receipt or label rolls.



Ref: BL-P3623

Adapter for receipt printing

Required for standard size receipt rolls.



Ref: 7POS000LNE_ _ _

DP Series single load cell platform (multi-range)

Aluminium/plastic structure, aluminium load cell, stainless steel plate.

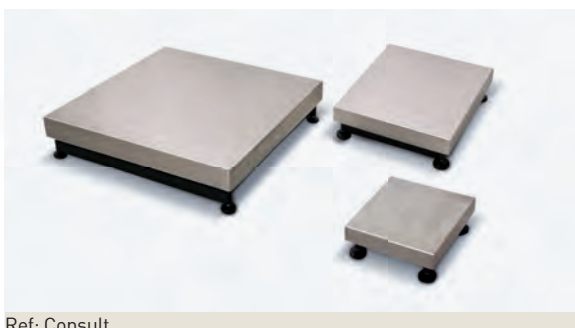

Ref: Consult

ME Series single load cell platforms (mono-range)

3 versions (see section on Platforms for further information).
For multi-range option, consult.



Ref: Consult

MA Series single load cell platforms (mono-range)

Iron structure, aluminium load cell, stainless steel plate (see section on Platforms for further information).

Note:

- The references correspond to standard models: Stainless steel casing, backlit LCD segment display, USB connector and TCP/IP Ethernet communications.

picto-grams

These are the pictograms you will find in this catalogue to highlight the equipment main characteristics.



DISPLAY
TYPE



TFT COLOUR
DISPLAY



TOUCH
SCREEN
CONSOLE
OR SCREEN



RS-232
CONNECTOR



USB
CONNECTOR

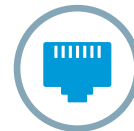

ETHERNET
CONNECTOR



WI-FI



NUMBER OF
PRINTERS AND
PRINTER TYPE



LINERLESS LABELS WITH AUTOCUTTER

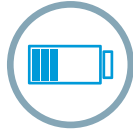

INTERNAL RECHARGEABLE BATTERY



PIT



WINDOWS OPERATING SYSTEM



NUMBER OF LOAD CELLS

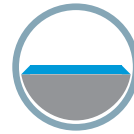

TOP-OF-FLOOR LOW PROFILE



LINUX OPERATING SYSTEM



CONNECTION TO PLATFORM AND NUMBER OF LOAD CELLS



ON WALL



MAXIMUM CAPACITY OF ARTICLES IN MEMORY



POSSIBILITY OF CONNECTION TO A 2ND PLATFORM OR MORE



AERIAL



INFORMATION ON HARD DISK



TOP-OF-FLOOR

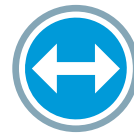

EQUIPMENT MOBILITY



NUMBER OF VENDORS/ OPERATORS



ON TABLE



FOLDING PLATE



EQUIPMENT METROLOGICAL VERIFICATION INFORMATION